



INSPIRING PROFILES

ORAC<sup>®</sup>  
DECOR

*'The making of'*

INSPIRING PROFILES

ORAC<sup>®</sup>  
DECOR

## The script

PO

Witamy w świecie marzeń ORAC DECOR®.

ORAC DECOR®. wyznacza standardy dla wysokiej jakości profili architektonicznych.

Cała nasza kolekcja wykonana jest przez i dla profesjonalistów z pasją, rzemieślników, którzy cenią sobie wysokiej jakości produkty, które są innowacyjne i łatwe w montażu.

Począwszy od listew przypodłogowych i profili oświetleniowych do multifunkcyjnych profili i gzymsów z charakterem. Nasze bardzo wysokiej jakości nowoczesne rozwiązania są funkcjonalne, dekoracyjne i dostosowane do każdego projektu. Z ORAC DECOR®. masz wszystkie atuty, aby zapewnić powodzenie projektu.

Jesteś reżyserem własnego filmu lub projektu. My oferujemy Ci wszystkie możliwe akcesoria lub rekwizyty, których potrzebujesz ażeby doprowadzić Twój projekt do finału

Wspólnie tworzymy niesamowity zespół, gotowy do pierwszego Oscara!

RU

Добро пожаловать в мир мечты ORAC DECOR®.

ORAC DECOR® устанавливает стандарт высококачественных архитектурных молдингов. Вся наша коллекция сделана специалистами для страстных профессионалов, мастеров, ценящих высокое качество продукции, которая инновационна и легка в монтаже. От плинтусов и карнизов скрытого освещения до многофункциональных профилей и карнизов с характером, наши высококачественные современные решения являются конструктивными, декоративными и адаптивными к любому проекту. С ORAC DECOR® у Вас есть все козыри, чтобы довести проект до выдающегося логического заключения.

Вы сами являетесь режиссером своего собственного фильма или проекта. Мы можем предложить Вам все возможные аксессуары, которые необходимы, чтобы превратить Ваш объект в шедевр. Вместе мы непобедимая команда, готовая к первому Оскару!

AR

مرحبا بكم في عالم أورك ديكور® السحري.

أورك ديكور® هو المرجعية للقوالب المعمارية العالية الجودة. تشكيلة كاملة مصنوعة من قبل ومن أجل محترفين مشغوفين، حرفيين مولعين بالمنتجات المبتكرة العالية الجودة والسهولة التركيب. من النعلات الى الكرائيش المحتوية على إضاءة غير مباشرة، مروراً بالقوالب المتعددة الإستعمالات، أصنافنا المعاصرة والعالية الجودة تتناسب مع كل مشروع. مع أورك ديكور® لديكم كل الأوراق الراجعة لتحقيق مشروعكم على أفضل وجه.

أنتم مخرجو فيلمكم أو مشروعكم. يمكننا أن نقدم لكم كل الأدوات واللوازم التي تحتاجونها لتحويل مشروعكم الى تحفة.

معا نشكل فريقاً رابحاً، جاهزاً للفوز بأول جائزة اوسكار.

FR

Bienvenue dans le monde féérique d'ORAC DECOR®.

ORAC DECOR® est la référence en matière de profilés architecturaux haut de gamme. Une collection complète, faite par et pour des spécialistes passionnés. Des stylistes amoureux des produits novateurs et faciles à installer, proposent des plinthes, des profilés d'éclairage indirect, des profilés multifonctions, en passant par des corniches de grand caractère.

Des solutions modernes, de haute qualité, fonctionnelles, décoratives spécifiques à chaque projet : Avec ORAC DECOR®, vous avez tous les atouts en main pour mettre votre projet sur les rails.

Vous êtes le réalisateur de votre propre film ou projet. Nous vous fournissons tous les accessoires et outils pour en faire une perle parmi les perles.

Ensemble, nous formons une équipe solide comme un roc, prête pour son premier Oscar!

EN

Welcome to the dream world of ORAC DECOR®.

ORAC DECOR® sets the standard for high quality architectural mouldings. Our complete collection is made by and for passionate professionals, craftsmen with logical minds who appreciate high quality products that are innovative and easy to install. From skirting boards and indirect lighting profiles to multifunctional profiles and cornices with character, our high quality contemporary solutions are functional, decorative and tailored to each project. With ORAC DECOR®, you have nothing but trumps in your hand to bring your project to an outstanding conclusion.

You are the director of your own film or project. We can offer you every possible accessory or prop that you need to turn your project into a showpiece.

Together, we make an unbeatable team, ready for the first Oscar!





**PUROTOUCH®**

- Wysokiej jakości, wysokiej gęstości poliuretan
- Качественный полиуретан высокой плотности
- Un polyuréthane moulé de haute densité
- A moulded quality high-density polyurethane
- بوليوريثين مقولب عالي الكثافة

**DUROPOLYMER®**

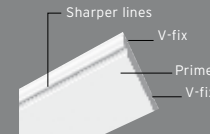
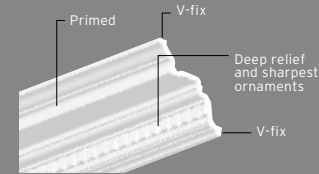

ref. Luzzus **LXX**

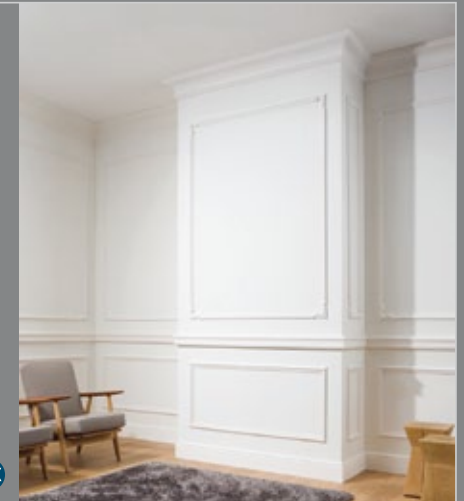

**DUROPOLYMER®**

- Ekstrudowany i odporny na uderzenia, dużej gęstości polistyren na bazie polimeru.
- Экструдированный и ударопрочный полимер, основанный на полистироле высокой плотности
- Un polymère extrudé résistant aux impacts à base d'un mélange de polystyrènes haute densité
- An extruded and impact-resistant polymer based on a high-density polystyrene
- بوليمر ميثوق ومقاوم للصدمات، من مزيج بوليستيرين عالي الكثافة

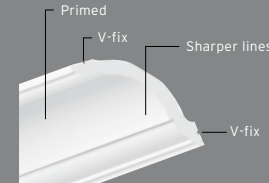

ref. Axxent **AXX**



**DUROFOAM®**

- Ekstrudowany lekki polimer oparty na średniej gęstości mieszance polistyrenu.
- Экструдированный легкий полимер, основанный на полистирольной смеси средней плотности
- Un polymère léger extrudé à base d'un mélange de polystyrènes de densité moyenne
- An extruded lightweight polymer based on a medium-density polystyrene blend
- بوليمر ميثوق وخفيف الوزن، من مزيج بوليستيرين متوسط الكثافة

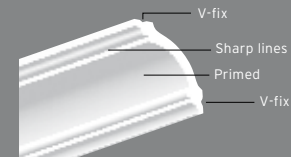

ref. Basixx **BXX**





DX121-2300

P72



PX103

P66

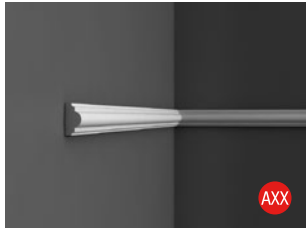

PX120

P66



PX114

P66



SX156

P69

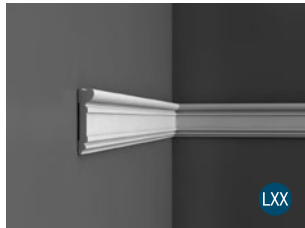

DX119-2300

P72

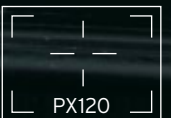
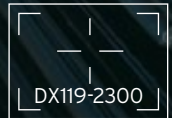
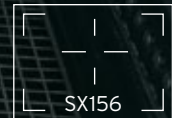
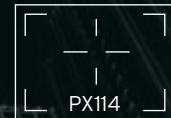
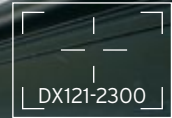



SX118F

P69



D62

P89

*Metiendo Vivendum - Louvain*

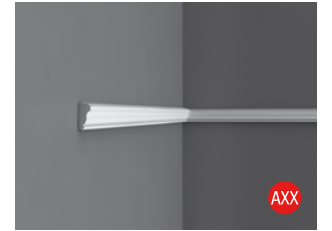

PX117

P66



PX113

P50



SX118

SX104

also starring in this collection ★



SX118

P69



PX103

P66



SX118F



SX118F

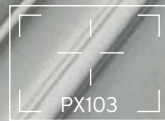



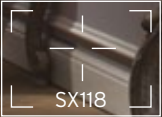

R40

P86

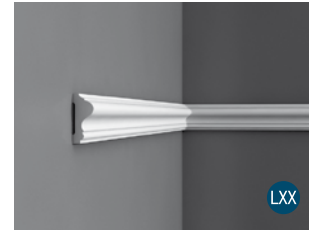

P8020/P8020F

P60

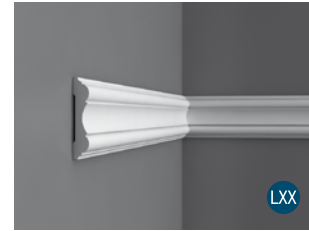

P8040

P62



SX118

P69

*Bucharest*

*Sofitel  
Brussels*



C322

P43



C332

P45



C333

P45



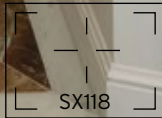
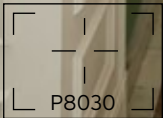
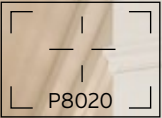
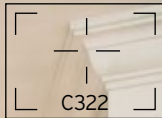

C322

LXX

P43



R38

LXX

P89



P8020

LXX

P60

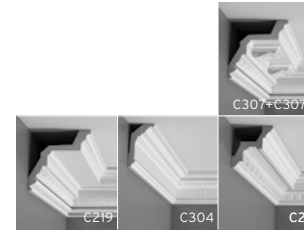

also starring in this collection ★



C422

LXX

P50

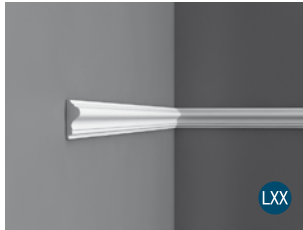

P8030

LXX

P60



also starring in this collection ★

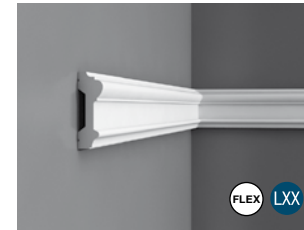

P9010/P9010F

FLEX LXX

P61



PX120

AXX

P66



SX118

LXX

P69



also starring in this collection ★



SX156

LXX

P69



PX103

AXX

P66

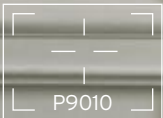
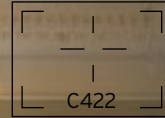





C217

LXX

P45



C321

★ also starring in this collection



C332

LXX

P45

★ also starring in this collection  
designed by Jaques Vergracht

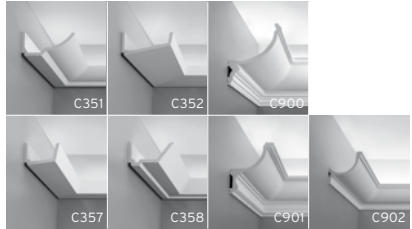

C351

C352

C900

C357

C358

C901

C902



C364

C363

C362

also starring in this collection ★  
designed by Pierre Daems



C361

LXX

P58/101



DX157-2300

AXX

P67/68

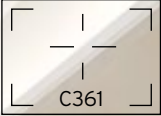

C361

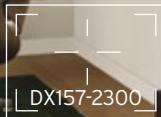

DX157-2300

*Lobby Amsterdam*



St-Petersburg



C300

P7070

SX118

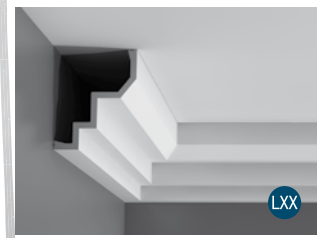

C300

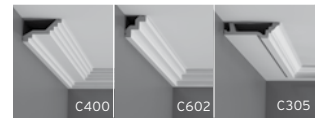

P47

★ also starring in this collection



P7070

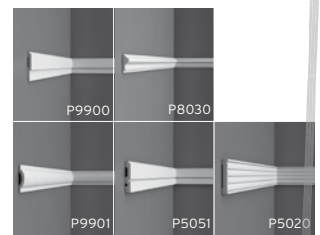

P61

★ also starring in this collection



SX118

P69

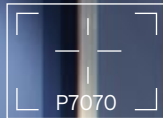



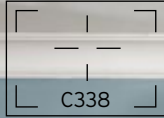
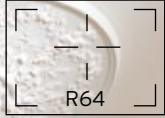

Take 1, lisbon



C338



P47

★ also starring in this collection

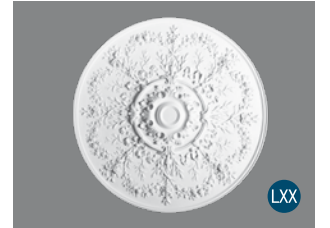

R64

P89



also starring in this collection ★



C336

P48



also starring in this collection ★

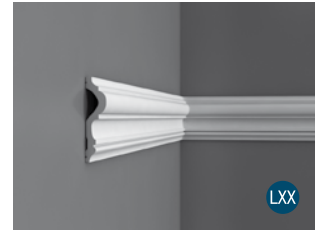

P8050

P62



also starring in this collection ★



SX156

P69

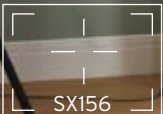
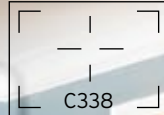
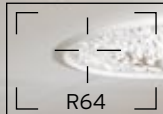
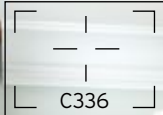

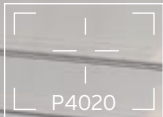



C990

LXX

P46

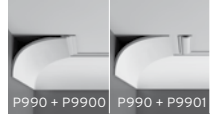

P990 + P9900 P990 + P9901

★ also starring in this collection  
designed by Xavier Donck



C335

also starring in this collection ★



C219

LXX

P50

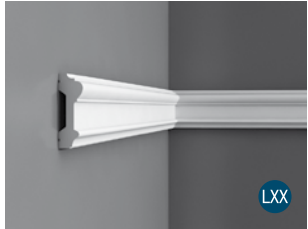

P9010

LXX

P61



P8050

also starring in this collection ★

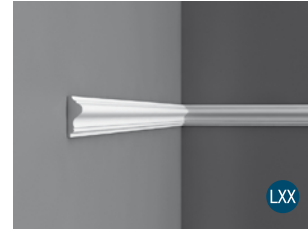

P8030

LXX

P60

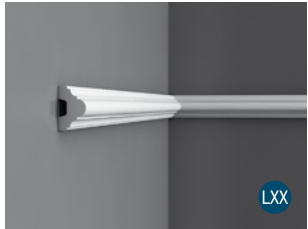

P4020

LXX

P60



PX103

AXX

P66



SX118

LXX

P69



SX104

★ also starring in this collection



SX156

also starring in this collection ★



SX155

LXX

P69

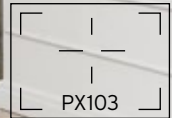
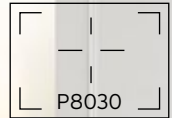



C217

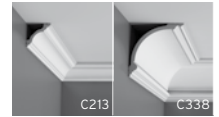

P45

★ also starring in this collection



P8030D

P62



P9010

P61

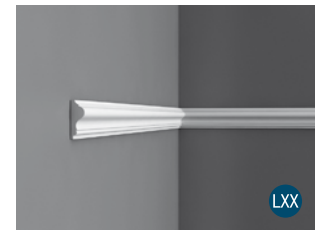

P8030

P60

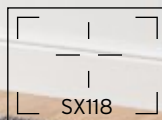

SX118



C307+C307A

P50

London  
Notting Hill



SX118

P69

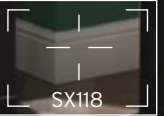
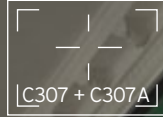

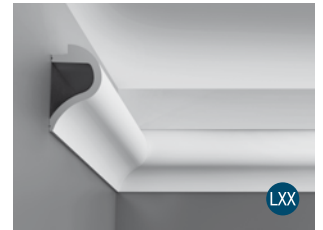

also starring in this collection ★  
designed by Pierre Daems

C364

P58/101



also starring in this collection ★



DX163-2300

P67/69



C357

P58/P101



★ also starring in this collection  
designed by Jaques Vergracht

*Indirect lighting  
Paris* →







C217



SX118

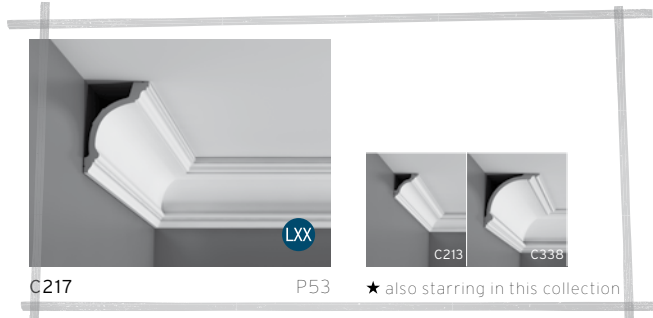

C217

P53

★ also starring in this collection

*Dressing Lady...  
Cambridge*



SX118

P66

★ also starring in this collection



also starring in this collection ★



CX106

P53



H101

P81

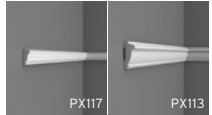

also starring in this collection ★



PX103/PX103A

P66

PX113	P66		
PX103	P66		
SX118	P69		



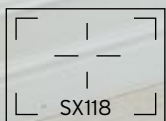
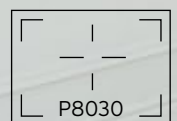
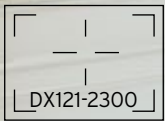
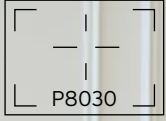
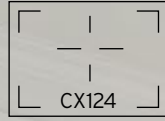

VIVALDI



*Chateau Mont-Royal  
Chantilly*



CX124

P52

AXX



★ also starring in this collection



P8030

P60

LXX

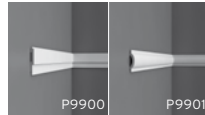

★ also starring in this collection



C322

P45

LXX

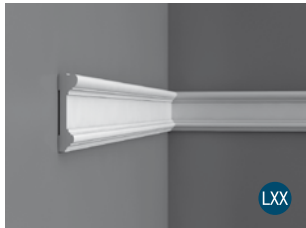

DX121-2300

P72

LXX



★ also starring in this collection



R08

P86

LXX



SX118

P69

LXX



★ also starring in this collection

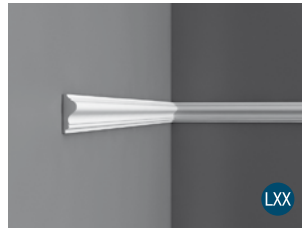

P8030/8030F

P60

LXX



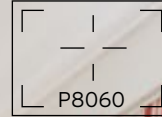



C335

P47

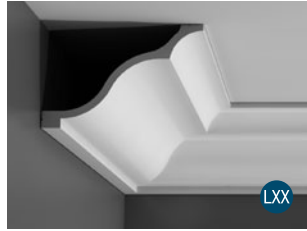

C337

P47

*Majestic Barcelona*

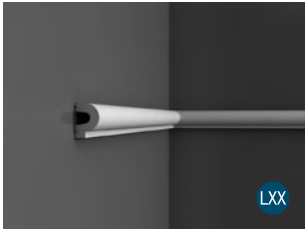

P8060

P60





CX107

PX103

CX107

PX103

SX118



CX107

P53

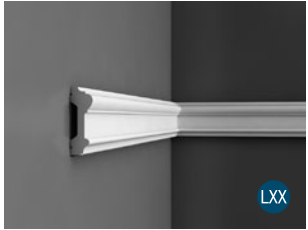

P9010

P61



PX103

P66

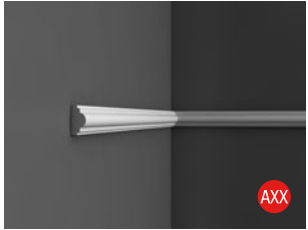

PX120

P66



CX107

P53

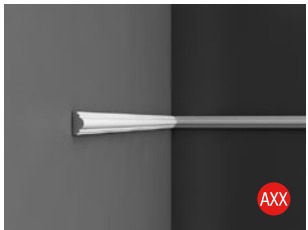

PX103

P66



SX118

P69



SX156

P69

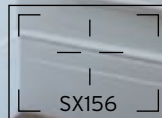
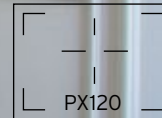
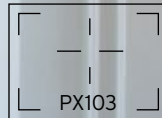
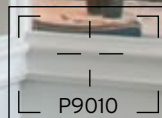



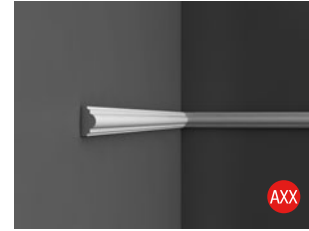

PX120

P66



PX103

P66

*Lounge  
Boca Grande*

*Boca Grande  
Barcelona*

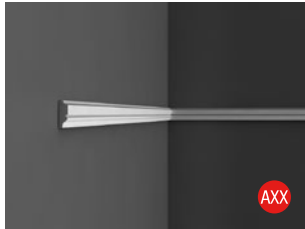

PX116

P66



PX144

P66

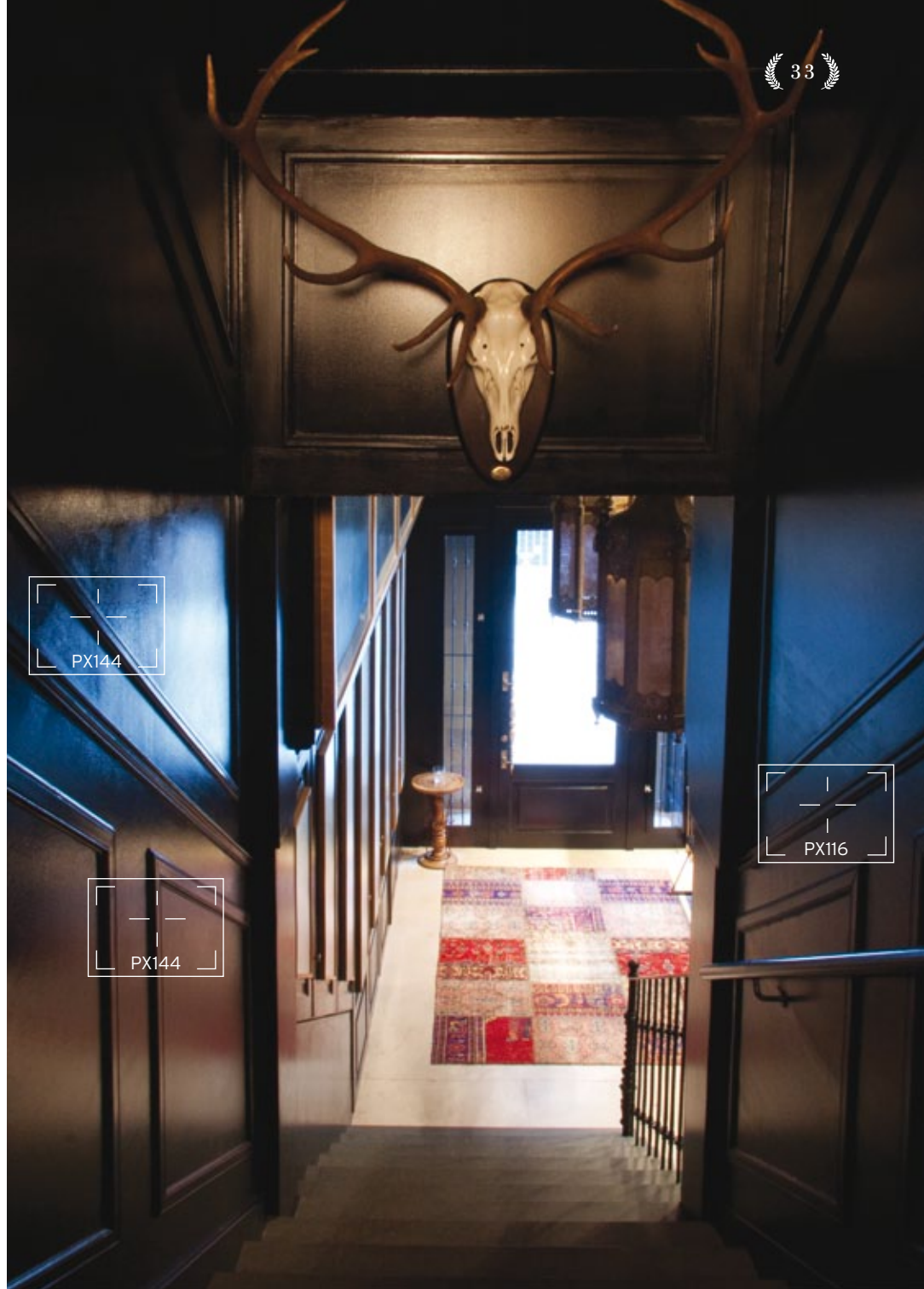



also starring in this collection ★



C334

P47

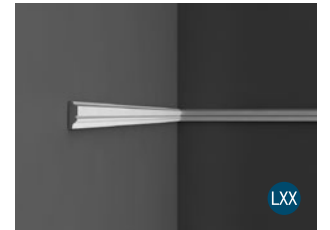

P9901

P47/60



also starring in this collection ★



SX156

P69

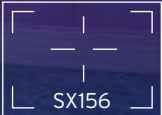

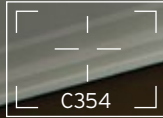

C354

P42



★ also starring in this collection

← Hamburg



C360

P42

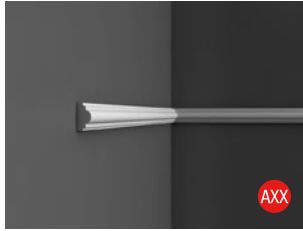

PX120

P66

AXX



C901

P45

LXX

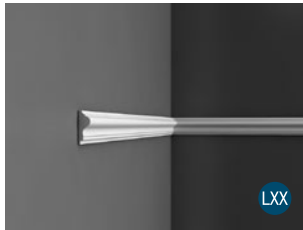

P8030

P60

LXX



SX118

P69

LXX

*Hotel Alma Barcelona*





# LUXXUS

## COLLECTION

PO

Luxxus zajmuje ekskluzywną pozycję w ramach marki ORAC DECOR®, ponieważ zawiera unikalny wybór luksusowych, kreatywnych profili i akcesoriów dekoracyjnych.

Szeroki asortyment zapewnia możliwość wykonania całej koncepcji z prawdziwym stylem.

Począwszy od gzymsów i profili dekoracyjnych, listew przypodłogowych i boazerii do systemów oświetleniowych i obudów drzwiowych, z których każde z tych rozwiązań posiada w sobie to przystawione coś. Różne profile łączy silny efekt wizualny jaki wywierają, co pozwala nadać odpowiednią atmosferę wnętrzu poprzez ich zaskakujący wygląd i kontury lub ich widoczne wymiary. Mówiąc krótko, w idealny sposób można zastosować te niezwykle wykończenia do wystroju wnętrz. Bardzo istotny jest również fakt, iż stale wprowadzamy innowacyjne i kreatywne pomysły wynikającą ze współpracy z znanymi projektantami.

To nie tylko niezwykle wzornictwo, ale również niezrównana jakość sprawia, że kolekcja Luxxus jest tak wyjątkowa. Profile wykonane są z wysokiej jakości tworzyw sztucznych takich jak Purotouch® (wysokiej gęstości poliuretan) i Duropolymer® (wysokiej gęstości polimer). Takie materiały o wypróbowanej jakości pozwalają na łatwy montaż.

RU

ORAC Luxxus – уникальный бренд в эксклюзивном ассортименте компании ORAC DECOR®. Коллекция ORAC Luxxus – это потрясающее собрание шикарных дизайнов и удивительных декоративных элементов. Полный перечень ассортимента ORAC Luxxus – воплощение гармоничного концепта истинного стиля: от карнизов и молдингов, плинтусов и облицовочных панелей, до систем освещения и дверного декора. Молдинги ORAC Luxxus отличаются замечательными формами и многообразием размеров. Каждый дизайн обладает сильным зрительным воздействием, задает изысканный тон интерьеру, добавляет оригинальности и придает законченность пространству. Для удобства коллекция разделена на четыре стиля: стиль кантри, современный стиль, традиционный стиль и королевский шик. Компания ORAC DECOR® постоянно работает над тем, чтобы привносить в продукцию новые инновационные идеи и творчество топ-дизайнеров. Не только дизайн, но и качество делает ORAC Luxxus особенным, уникальным брендом. Молдинги производятся из высококачественных материалов, Purotouch® (высококачественный полиуретан) и Duropolymer® (дюрополимер, полимер высокой плотности). Каждый из материалов является высокотехнологичной разработкой. Их высокое качество дополняет эстетические достоинства продукции ORAC Luxxus великолепными техническими характеристиками: легкость в монтаже и устойчивость к внешним воздействиям.

AR

تحتل لوكسس موقعا إستثنائيا ضمن مجموعة أورك ديكور، كونها تشمل تشكيلة فريدة من القوالب والأكسسوارات الزخرفية المبتكرة الفخمة. تتضمن التشكيلة كرائيش، قوالب وتليبيسات للجدران، نعلات، إطارات للأبواب، أنظمة للإضاءة... مجموعة كاملة لتصميم جمالي متكامل ومتميز بعد تركيبها، تحدث القوالب مجتمعة تأثيرا بصريا قويا وأنيقا، وتعطي جوا مميزا للمنزل، إننا نعمل باستمرار على إضافة أفكار وإبتكارات جديدة من كبار المصممين الى تشكيلة لوكسس الواسعة. تتميز تشكيلة لوكسس بتصميمها الفريدة من نوعها وجودتها الفائقة. قوالب لوكسس مصنوعة من مواد بلاستيكية عالية الجودة مثل بيوروتاتش® (بوليوريثين عالي الجودة) ودوروبوليمر® (بوليمر عالي الكثافة)، وهي مواد ذات نوعية عالية تسمح بتركيب سهل.

FR

Occupant une place exclusive dans la marque ORAC DECOR®, la gamme Luxxus comprend un choix inouï de profilés créatifs et d'accessoires décoratifs de luxe: moulures de plafond et murales, plinthes, lambris, décorations de portes et systèmes d'éclairage... Bref, une gamme complète pour un concept total esthétique, qui se distingue par son style. Combinées, les différentes moulures ont un impact visuel puissant et élégant. Originales, travaillées ou monumentales, elles contribuent à définir l'atmosphère de votre intérieur, à lui donner l'accent qui fera sa finition magistrale. La gamme étendue est complétée en permanence par des idées et créations innovantes de concepteurs de pointe.

La gamme Luxxus se distingue par son design exceptionnel et sa qualité irréprochable. Les moulures sont fabriquées dans des matières synthétiques de qualité supérieure, telles que

le Purotouch® (un polyuréthane haut de gamme) et le Duropolymer® (un polymère haute densité). Des matériaux dont la qualité prouvée permet une installation rapide.

EN

Luxxus occupies an exclusive position within the overall ORAC DECOR® brand, as it contains a unique selection of luxury creative profiles and decorative accessories. A complete range to provide a total concept with real style - from cornices and panel mouldings, skirting-boards and wainscoting to lighting systems and door furniture, all with that little extra something. The different mouldings are united in their strong visual impact, which means they help set the tone of your interior with their striking looks and contours or their conspicuous dimensions. In short, the ideal way to put that out-of-the-ordinary finishing touch to your decor. And what is more, we are continually adding innovative ideas and creations from top designers. It's not just its remarkable design but also its impeccable quality that makes Luxxus so special. The mouldings are made from top quality plastics such as Purotouch® (high-grade polyurethane) and Duropolymer® (a high-density polymer) - materials of well-proven quality that also allow easy fitting.







# AXXENT

## COLLECTION

PO

Axxent, kolekcja ORAC DECOR®, jest to wysokiej jakości gama wykończeń. Kolekcja oferuje klientom wysokiej jakości rozwiązania w przystępnej cenie. Zawiera gzymsy i profile dekoracyjne, obudowy drzwiowe i multifunkcyjne profile. Odkryj świat możliwości i rozwiązań z kolekcją Axxent. Wszystkie produkty Axxent wykonane są z Duropolymer®, ekstrudowanej, odpornej na uderzenia i wodę o wysokiej gęstości mieszanki polimerowej. Jest to doskonały materiał na listwy przypodłogowe i opaski drzwiowe. Inna ważną zaletą Duropolymer®, jest fakt, iż podlega on 100% recyklingowi.

RU

ORAC Axxent – это коллекция высококачественного лепного декора бренда ORAC DECOR®, которая включает в себя карнизы, молдинги, плинтусы, декор для дверных проемов и многофункциональные профили, что позволяет декораторам создавать первоклассные интерьеры по доступной цене. Откройте для себя мир безграничных возможностей лепного декора ORAC Axxent. Все изделия ORAC Axxent сделаны из материала дюрполимер (Duropolymer®) – экструдированного, ударопрочного и водостойкого полимера. Это идеальный материал для плинтусов и дверных проемов. Еще одно важное преимущество: дюрполимер (Duropolymer®) на 100% пригоден для переработки.

AR

تشكيلة أكسنت من أوراك ديكور® هي مجموعة من القوالب العالية الجودة. توفر هذه التشكيلة حلول وخيارات عديدة تساعد مهندسي الديكور على تقديم نوعية عمل ممتازة بأسعار في متناول الجميع. تشمل المجموعة كرانيش، قوالب للجدران، نعلات، إطارات للأبواب وأصناف متعددة الإستعمالات. إكتشفوا عالم من الإمكانيات والحلول مع أكسنت. جميع أصناف أكسنت مصنوعة من دوروبوليمر® وهو مزيج بوليمرات ميثوق، عالي الكثافة ومقاوم للماء والصدمات. إنه إن مادة دوروبوليمر® قابلة لإعادة التدوير 100%.

FR

Axxent, une collection d'ORAC DECOR®, est un choix de moules universelles de qualité. Une gamme complète pour fournir un travail de qualité à un prix abordable. Un choix de corniches, de cimaises, de plinthes, d'encadrements de porte et de moules multifonctionnelles. Découvrez aujourd'hui un univers plein de possibilités et de solutions avec Axxent. Tous les produits Axxent sont réalisés en Duropolymer®, un mélange de polymères extrudés de haute densité, résistant aux chocs et à l'eau. Le matériau idéal pour les plinthes et les encadrements de porte. En plus: Duropolymer® est 100% recyclable.

EN

Axxent, a collection by ORAC DECOR®, is a high-quality, solution-oriented range of mouldings. This complete range helps skilled decorators to deliver first-rate work at an affordable price. It includes cornice and panel mouldings, door frames and multifunctional profiles. Discover a world of possibilities and solutions with Axxent. All Axxent products are made from Duropolymer®, an extruded, impact and water resistant high-density polymer blend. It's the perfect material for skirting and door frames. Another important advantage: Duropolymer® is 100% recyclable.



# BASIXX

## COLLECTION



### PO

Od czasu swojej premiery, Basixx, kolekcja ORAC DECOR® jest adresowana do ludzi młodych lubiących modne rozwiązania. Dzięki wprowadzeniu pięciu nowych modeli gama produktów jest naprawdę kompletna. Pomysłowa, oryginalna i niedroga kolekcja uzupełnia w ponadczasowy sposób każde wnętrze. Dzięki zastosowaniu profili łączących w elegancki sposób ścianę z sufitem uwolnimy grę światła i cienia w naszym pomieszczeniu. ORAC DECOR® zdecydował się zaferować swoim klientom prostą koncepcję w postaci rodziny gzymsów, każda z tych rodzin posiada dopasowane profile do odpowiedniego stylu. W ten sposób produkty z jednej rodziny mogą być zastosowane do każdego pomieszczenia w domu. Wszystkie produkty Basixx wykonane są, z Durofoam®, ekstrudowanej, lekkiej mieszanki polimeru o średniej gęstości. Inną ważną zaletą Durofoam® jest fakt, iż podlega on 100% recyklingowi.

### RU

С момента своего выпуска, коллекция Basixx компании ORAC DECOR® была адресована молодым и модным клиентам. Благодаря введению пяти новых моделей, ассортимент теперь действительно полон. Изобретательная, оригинальная и бюджетная коллекция, которая завершает каждый интерьер. Эти декоративные элементы, в сочетании со стеной и потолком, могут разразиться элегантной игрой света и тени. Компания ORAC DECOR® решила предложить своим клиентам простую концепцию, в

которой разработаны разные семьи, каждая из которых включает карнизы различных стилей. Таким образом, товары из одной и той же семьи могут быть использованы для каждой комнаты в доме. Все изделия Basixx сделаны из Durofoam® - экструдированного, легкого полимера, основанного на полимерной смеси средней плотности. Еще одно важное преимущество: Durofoam® на 100% пригоден для переработки.

### AR

منذ إطلاقها، تتوجه مجموعة بيزكس من أورك ديكور® إلى جمهور شاب وعصري. وقد إكتملت هذه التشكيلة بإدخال خمسة تصاميم جديدة. مجموعة مميزة ومنخفضة التكلفة، لإطفاء لمسة لا تفنى على كل منزل. هذه القوالب الزخرفية تصل الجدار بالسقف بشكل أنيق يولد تأثير جميل من الضوء والظل. تقدم أورك ديكور® لزبائننا مجموعات كرائيش من طرازات مختلفة، لتناسب مع مختلف أنواع المنازل، فيتمكن الزبون من إختيار كرائيش متناسقة لكل اقسام المنزل من ضمن المجموعة التي تتماشى مع نوع منزله. جميع أصناف بيزكس مصنوعة من دوروفوم®، وهو مزيج بوليمرات ميثوق متوسط الكثافة. بالإضافة إلى ذلك، إن مادة دوروفوم® قابلة لإعادة التدوير 100%.

### FR

Avec la collection Basixx, ORAC DECOR® s'adresse depuis son lancement à un public jeune et branché. Et les cinq nouveaux modèles introduits complètent vraiment la collection. Une collection inventive, originale et à faible coût pour une finition intemporelle de n'importe quel intérieur. Ces moulures décoratives assurent une parfaite jonction mur /plafond qui laisse éclater le jeu d'ombres et de lumières. ORAC DECOR® a choisi de proposer à ses clients un concept simple, et a développé pour ce faire des familles de plusieurs corniches chacune par type de maison. Le client peut ainsi utiliser différentes corniches d'une même famille pour les différents espaces de vie de sa maison. Tous les produits Basixx sont réalisés en Durofoam®, un mélange de polymères extrudés de densité moyenne. En plus: Durofoam® est 100% recyclable.

### EN

Since its launch, the Basixx collection by ORAC DECOR® has been addressing a young and trendy clientele. Thanks to the introduction of five new models the range is now really complete. An inventive, original and budget-friendly collection that completes each interior in a timeless way. These ornamental frames connect wall and ceiling elegantly so the play of light and shadow can burst out. ORAC DECOR® chose to offer its customers a simple concept for which it developed different families, each with different cornices per style. This way, products from the same family can be used for each room in the house. All Axxent products are made from Durofoam®, an extruded lightweight polymer based on a medium-density polymer blend. Another important advantage: Durofoam® is 100% recyclable.

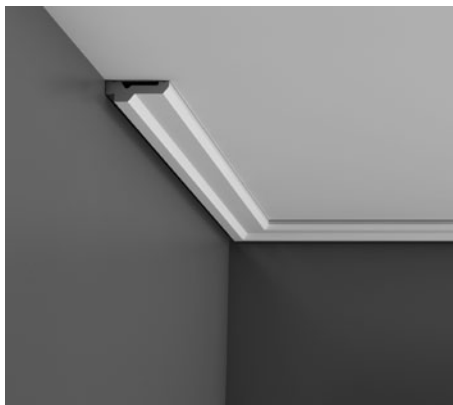

C360

PUROTOUCH®  
200 x 2 x 6 cm



C356

PUROTOUCH®  
200 x 2 x 10 cm

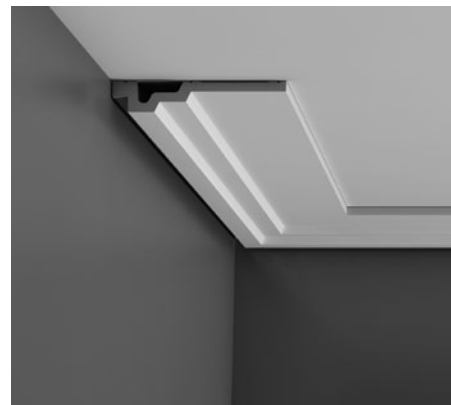

C353

PUROTOUCH®  
200 x 3 x 16,5 cm



C355

PUROTOUCH®  
200 x 3,5 x 11 cm



C354

PUROTOUCH®  
200 x 4 x 21,5 cm

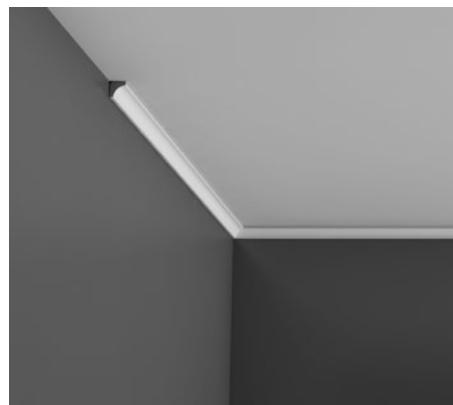

C250/C250F

PUROTOUCH®  
200 x 1,5 x 1,5 cm

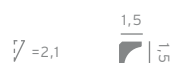

C230/C230F

PUROTOUCH®  
200 x 3 x 3 cm

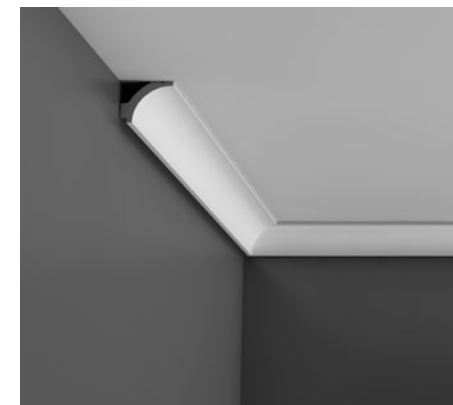

C260/C260F

PUROTOUCH®  
200 x 4 x 5 cm





C305

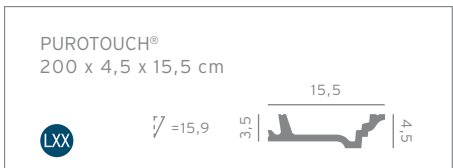

C305 + C212

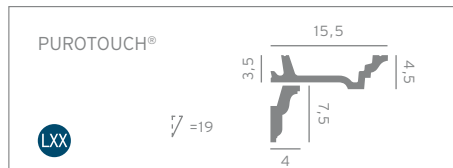

C305 + C213

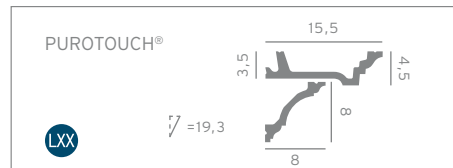

C305 + C321



C305 + C211



C215/C215F

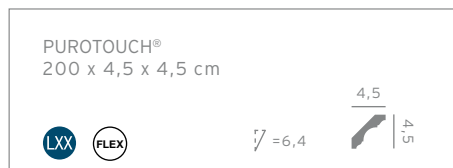

C322/C322F

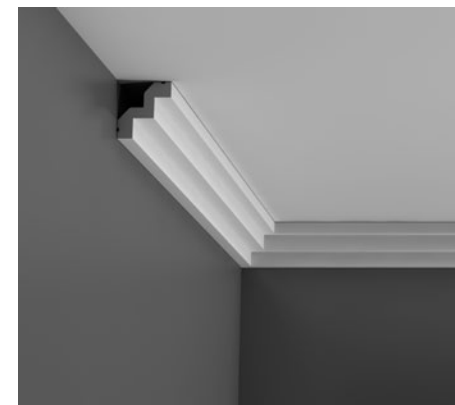
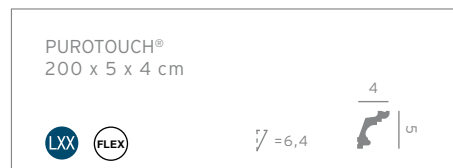

C602/C602F

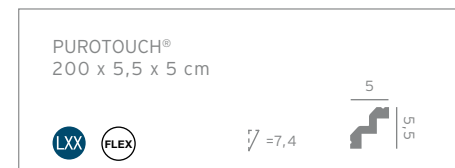

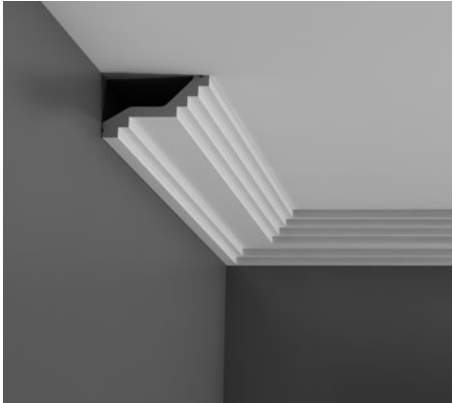

C400

PUROTOUCH®  
200 x 6 x 10 cm

LXX

∠ = 11,7



C331/C331F

PUROTOUCH®  
200 x 6 x 13,5 cm

LXX FLEX

∠ = 14,8



C200/C200F

PUROTOUCH®  
200 x 6,5 x 5,5 cm

LXX FLEX

∠ = 8,4



C220/C220F

PUROTOUCH®  
200 x 7,5 x 11,5 cm

LXX FLEX

∠ = 13,7



C213/C213F

PUROTOUCH®  
200 x 8 x 8 cm

LXX FLEX

∠ = 11,3

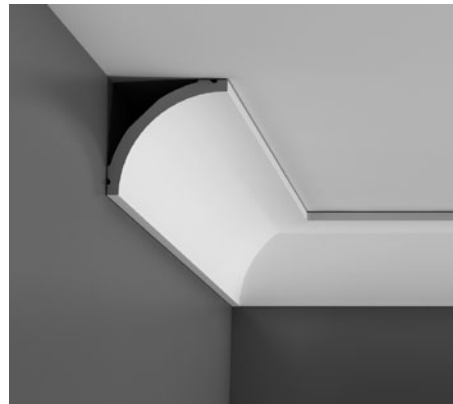

C240/C240F

PUROTOUCH®  
200 x 8 x 8 cm

LXX FLEX

∠ = 11,3



C321/C321F

PUROTOUCH®  
200 x 10 x 5 cm

LXX FLEX

∠ = 11,2



C902/C902F

PUROTOUCH®  
200 x 10 x 10 cm

LXX FLEX

∠ = 14,1



C217/C217F

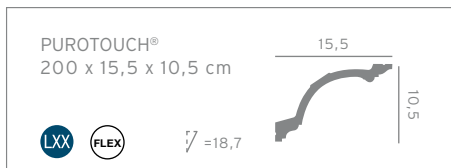

C332



C333/C333F

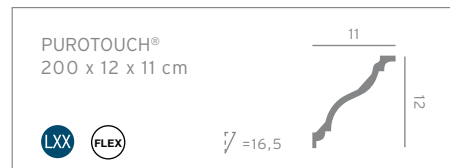

C339/C339F

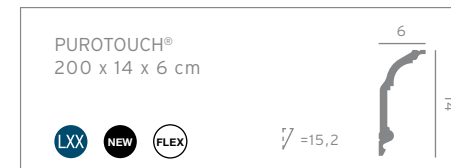

C334/C334F

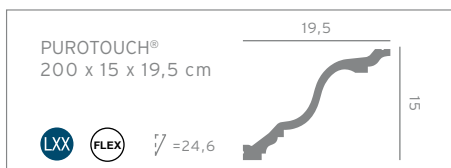

C901/C901F

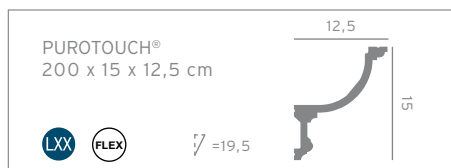

C217/C217F



C900

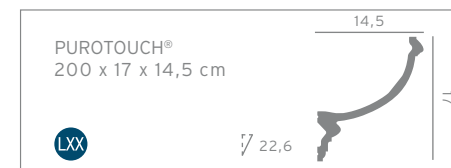



C990 - Designed by Xavier Donck

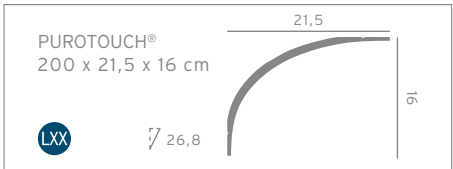

C990 + P9900 - Designed by Xavier Donck

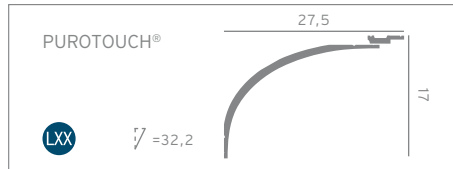

C990 + 2x P9900 - Designed by Xavier Donck

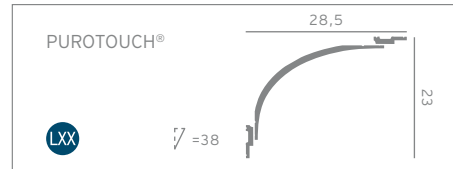

C990 + P9900 - Designed by Xavier Donck

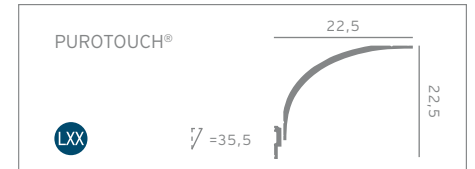

C990 - Designed by Xavier Donck

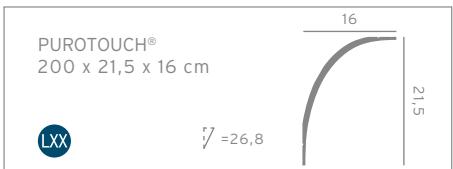

C990 + P9900 - Designed by Xavier Donck



C990 + 2x P9900 - Designed by Xavier Donck



C990 + P9900 - Designed by Xavier Donck

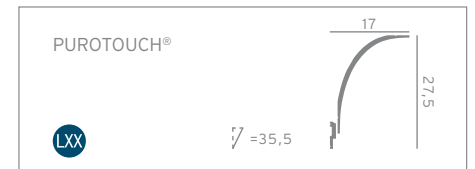



C990 + P9901 - Designed by Xavier Donck

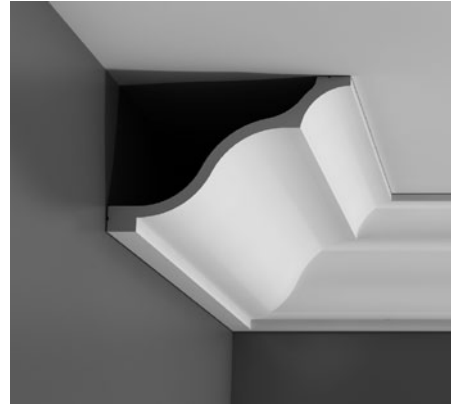
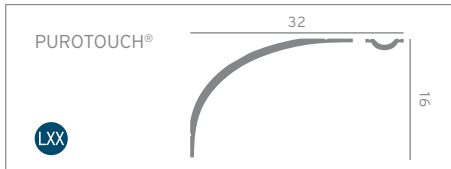

C337

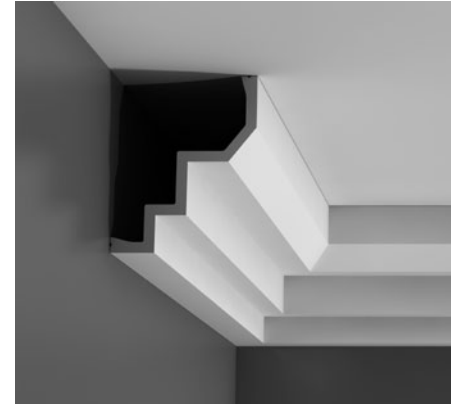
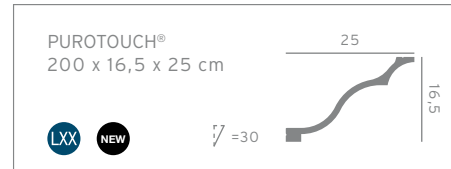

C300

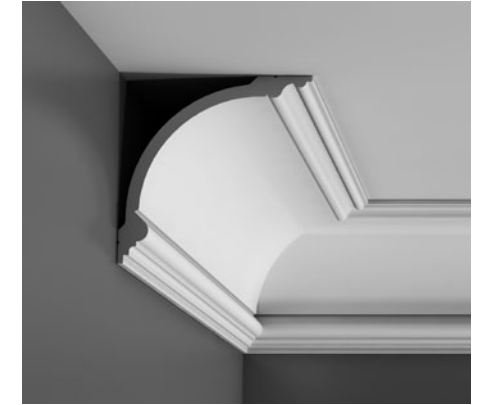
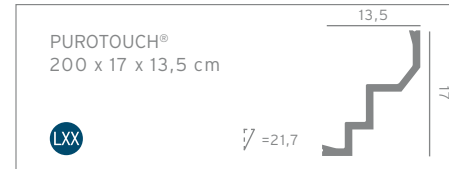

C338



C990 + P9901 - Designed by Xavier Donck

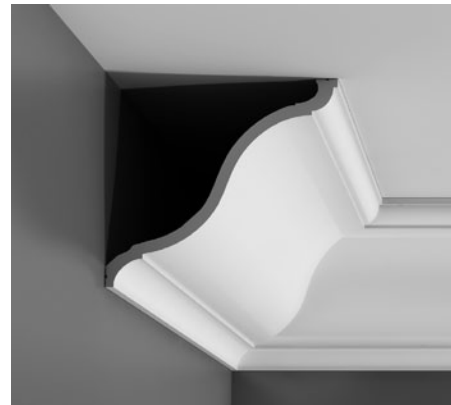

C335 - Designed by Xavier Donck

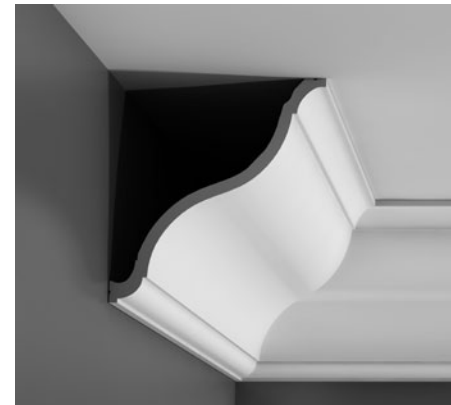
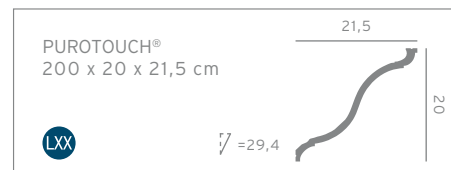

C335 - Designed by Xavier Donck

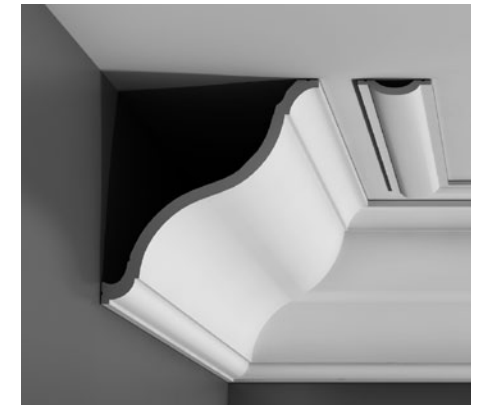
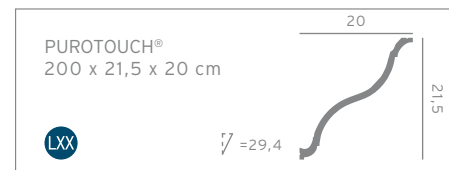

C335 + P9901 - Designed by Xavier Donck

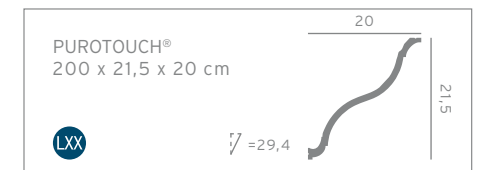





C332

PURROTOUCH®  
200 x 23 x 11,5 cm

LXX NEW

$\nabla = 25,7$

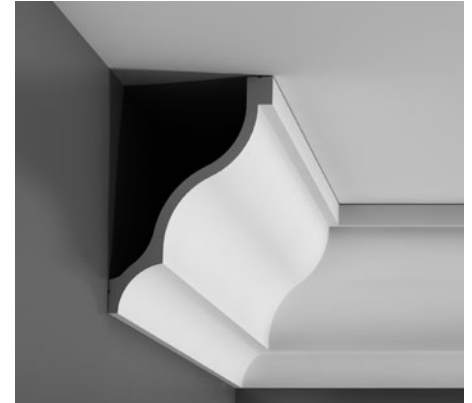

C337

PURROTOUCH®  
200 x 16,5 x 25 cm

LXX NEW

$\nabla = 30$



C340

PURROTOUCH®  
200 x 25,5 x 13,5 cm

LXX NEW

$\nabla = 28,7$



C336

PURROTOUCH®  
200 x 27 x 26 cm

LXX

$\nabla = 37,5$



C214/C214F

PUROTOUCH®  
200 x 6,5 x 3 cm

LXX FLEX

$\nabla = 7,2$



C212/C212F

PUROTOUCH®  
200 x 7,5 x 4 cm

LXX FLEX

$\nabla = 8,5$



C402/C402F

PUROTOUCH®  
200 x 9,5 x 10,5 cm

LXX FLEX

$\nabla = 14,4$



C216/C216F

PUROTOUCH®  
200 x 11,5 x 13,5 cm

LXX FLEX

$\nabla = 17,7$



C201/C201F

PUROTOUCH®  
200 x 11,5 x 5 cm

LXX FLEX

$\nabla = 12,5$



C211/C211F

PUROTOUCH®  
200 x 11,5 x 11 cm

LXX FLEX

$\nabla = 15,9$



C304/C304F

PUROTOUCH®  
200 x 12 x 7 cm

LXX FLEX

$\nabla = 13,9$



C302/C302F

PUROTOUCH®  
200 x 12,5 x 8 cm

LXX FLEX

$\nabla = 14,8$



C303/C303F

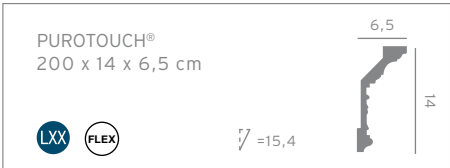

C218/C218F

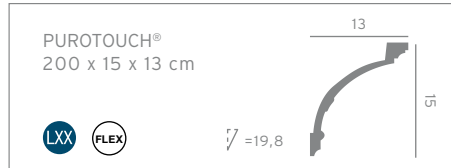

C422

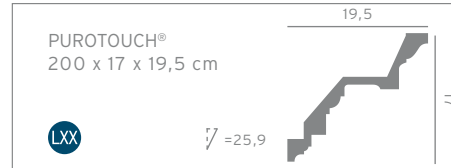

C301/C301F

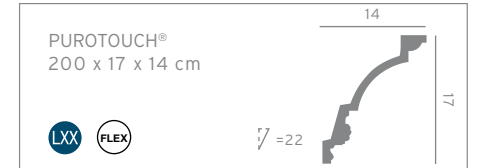

C219

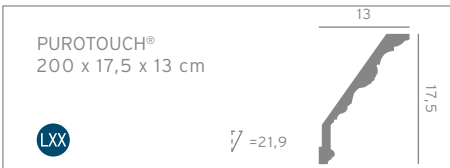

C307

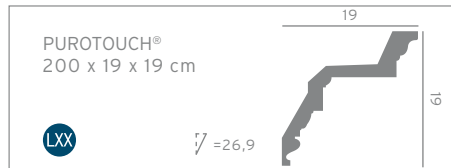

C307 + C307A

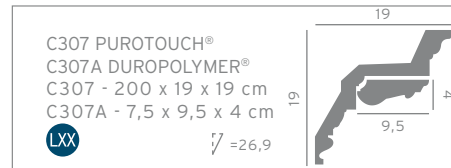

C308/C308F

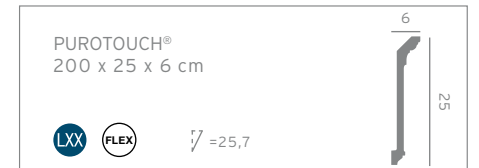

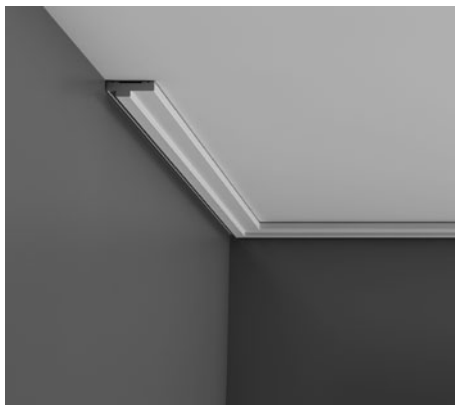

CX160

DUROPOLYMER®  
200 x 1,3 x 4 cm



∇ = 4,2



CX161

DUROPOLYMER®  
200 x 1,3 x 7 cm



∇ = 11,3



CX132

DUROPOLYMER®  
200 x 2 x 2 cm



∇ = 2,8



CX133

DUROPOLYMER®  
200 x 2 x 2 cm



∇ = 2,8



CX111

DUROPOLYMER®  
200 x 2,5 x 1,5 cm



∇ = 2,9



PX164

DUROPOLYMER®  
200 x 3 x 2,5 cm



∇ = 3,9

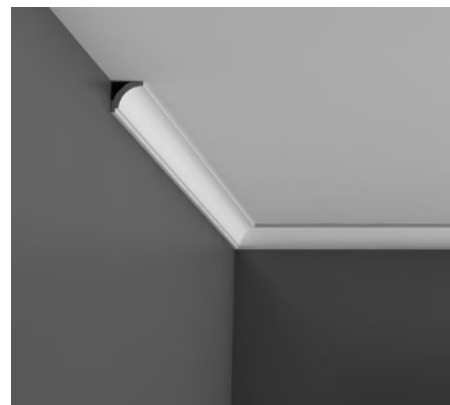

CX115

DUROPOLYMER®  
200 x 3 x 3 cm



∇ = 4,2



CX154

DUROPOLYMER®  
200 x 3 x 3 cm



∇ = 4,2





CX148

DUROPOLYMER®  
200 x 3 x 4,5 cm



∇ = 5,4



CX110

DUROPOLYMER®  
200 x 4,5 x 4 cm



∇ = 6

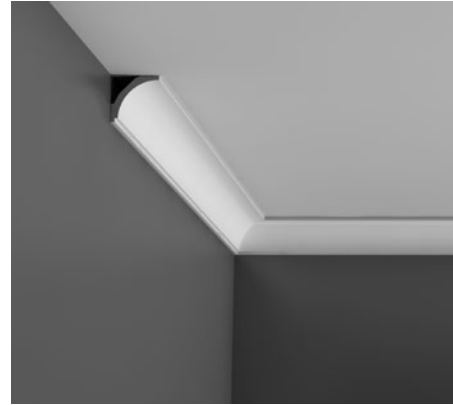

CX109

DUROPOLYMER®  
200 x 4,5 x 4,5 cm



∇ = 6,4



CX124

DUROPOLYMER®  
200 x 5 x 5 cm



∇ = 7,1



CX112

DUROPOLYMER®  
200 x 5,5 x 4 cm



∇ = 7,1



CX108

DUROPOLYMER®  
200 x 5,5 x 5,5 cm



∇ = 7,8



CX100

DUROPOLYMER®  
200 x 7 x 7 cm



∇ = 9,9



CX123

DUROPOLYMER®  
200 x 8 x 8 cm



∇ = 11,3



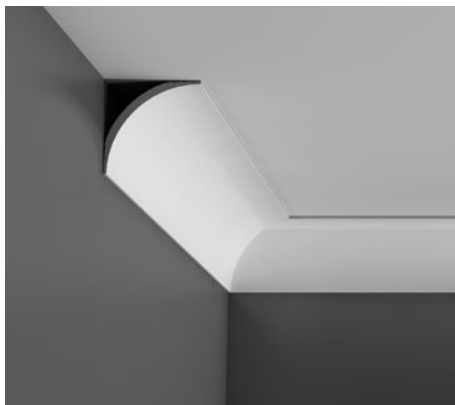

CX126

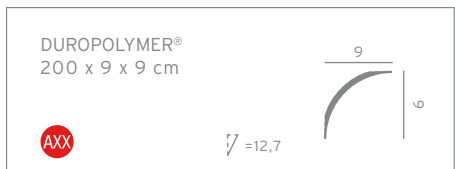

CX127

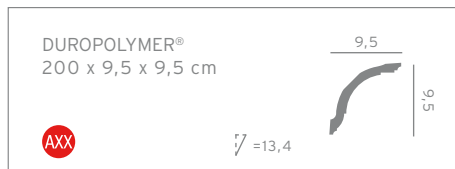

CX106

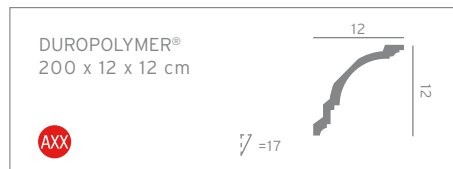

CX101

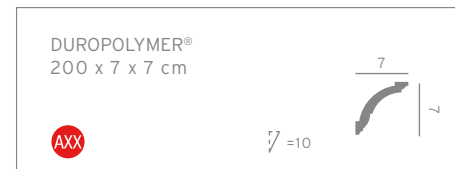

CX136

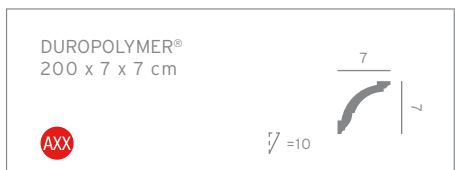

CX128

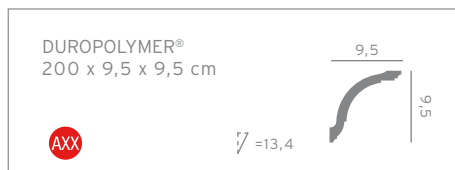

CX129

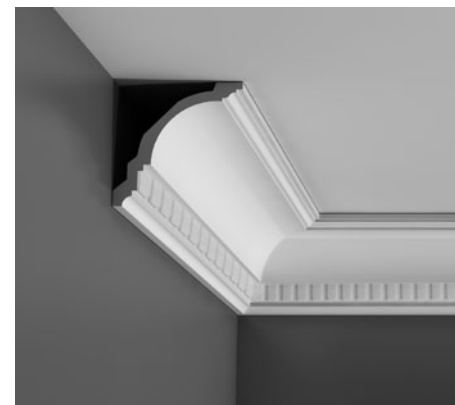
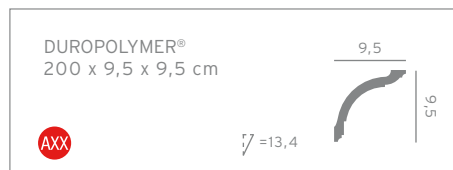

CX107

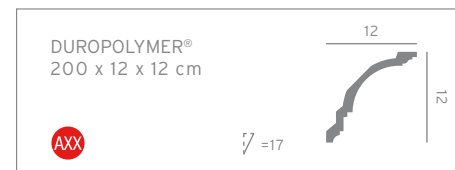



CX149

DUROPOLYMER®  
200 x 4,5 x 3 cm

$\nabla = 5,4$



CX150

DUROPOLYMER®  
200 x 4,5 x 3 cm



CX151

DUROPOLYMER®  
200 x 4 x 2,5 cm



CX152

DUROPOLYMER®  
200 x 4 x 2,5 cm



CX153

DUROPOLYMER®  
200 x 4 x 2,5 cm

$\nabla = 7,1$



CX141

DUROPOLYMER®  
200 x 6 x 3,5 cm



CX142

DUROPOLYMER®  
200 x 6 x 3,5 cm





CX143

DUROPOLYMER®  
200 x 6 x 3,5 cm





DX162-2300

DUROPOLYMER®  
230 x 1 x 4 cm





DX159-2300

DUROPOLYMER®  
230 x 1,2 x 6 cm





DX157-2300

DUROPOLYMER®  
230 x 1,3 x 6,5 cm

DX163-2300

DUROPOLYMER®  
230 x 1,3 x 10 cm





CB500

DUROFOAM®  
200 x 2,5 x 2 cm

BXX

∇ = 3,2



CB530

DUROFOAM®  
200 x 2,7 x 1,5 cm

BXX NEW

∇ = 3,1



CB530

DUROFOAM®  
200 x 2,7 x 1,5 cm

BXX NEW

∇ = 3,1

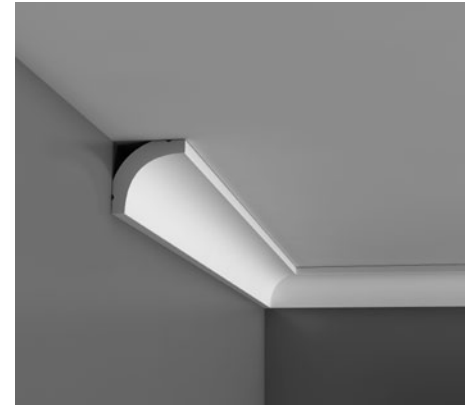

CB520

DUROFOAM®  
200 x 3,5 x 3,5 cm

BXX

∇ = 5



CB501

DUROFOAM®  
200 x 4 x 3,5 cm

BXX

∇ = 5,3



CB510

DUROFOAM®  
200 x 4 x 4 cm

BXX

∇ = 5,7



CB523

DUROFOAM®  
200 x 6 x 4 cm

BXX

∇ = 7,2



CB531

DUROFOAM®  
200 x 4,5 x 2,5 cm

BXX NEW

∇ = 5,2



CB531

DUROFOAM®  
200 x 4,5 x 2,5 cm

BXX NEW

$\sphericalangle = 5,2$



CB521

DUROFOAM®  
200 x 5 x 5 cm

BXX

$\sphericalangle = 7,1$



CB502

DUROFOAM®  
200 x 6 x 5 cm

BXX

$\sphericalangle = 7,8$



CB522

DUROFOAM®  
200 x 7 x 7 cm

BXX

$\sphericalangle = 9,9$



CB511

DUROFOAM®  
200 x 7 x 7 cm

BXX

$\sphericalangle = 10$

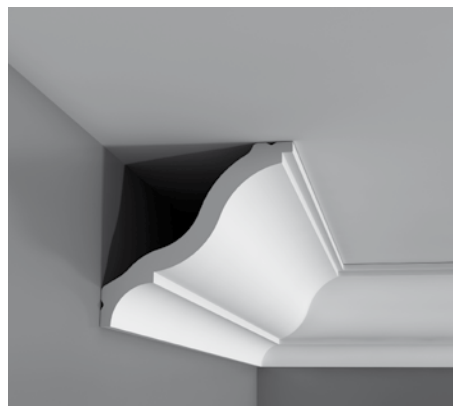

CB503

DUROFOAM®  
200 x 8,5 x 9 cm

BXX NEW

$\sphericalangle = 12,4$

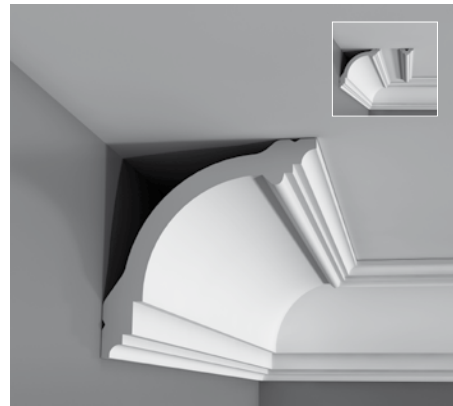

CB512

DUROFOAM®  
CB512 - 200 x 10 x 10 cm  
PB513 - 200 x 1,5 x 3,5 cm

BXX NEW

$\sphericalangle = 14,1$



PB513 + PB513A

PB513 - DUROFOAM®  
PB513A - DUROPOLYMER®  
PB513 - 200 x 1,5 x 3,5 cm  
PB513A - 18 x 7 x 1,5 cm

BXX NEW

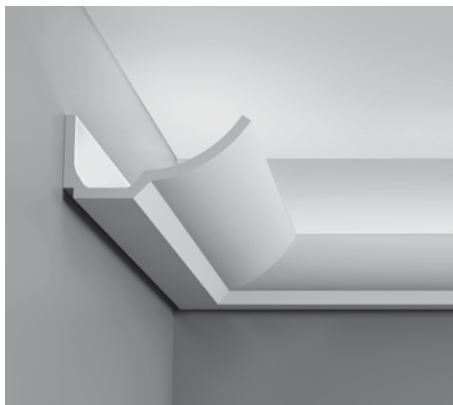

C351 - Designed by Jacques Vergracht

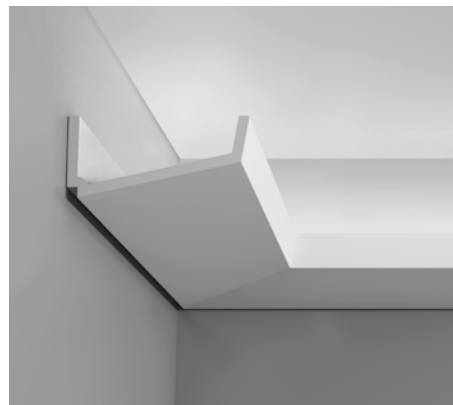
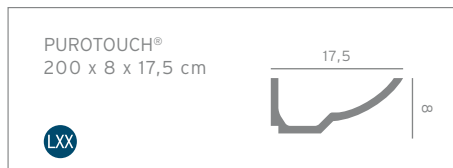

C352 - Designed by Jacques Vergracht

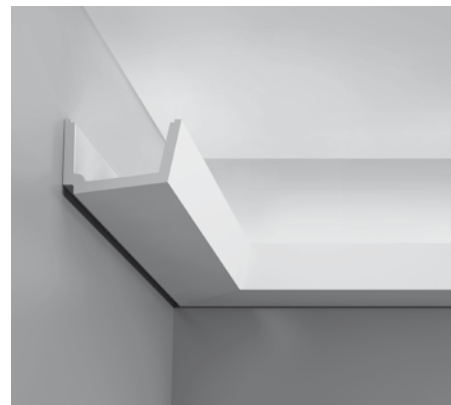
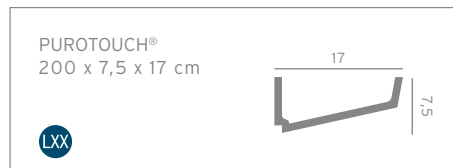

C357 - Designed by Jacques Vergracht

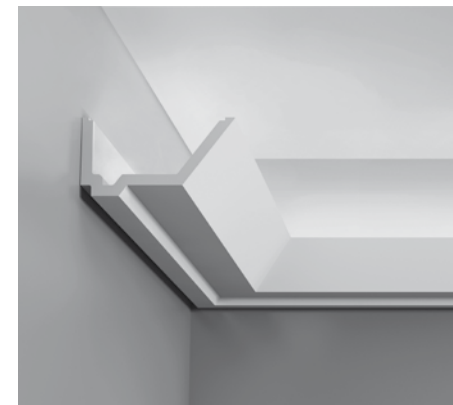
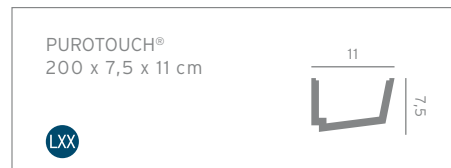

C358 - Designed by Jacques Vergracht

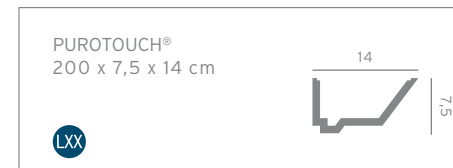

C361 - Designed by Pierre Daems

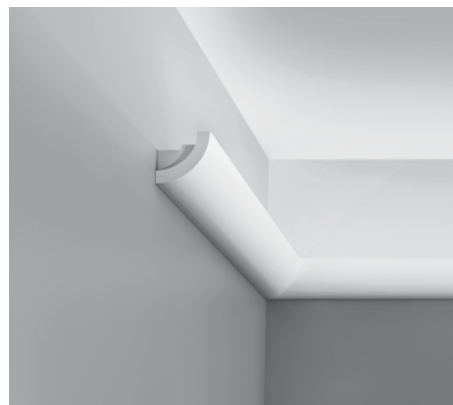
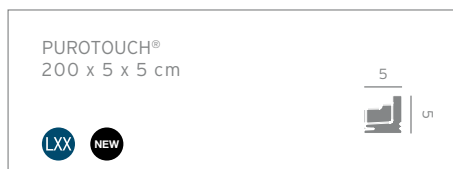

C362 - Designed by Pierre Daems

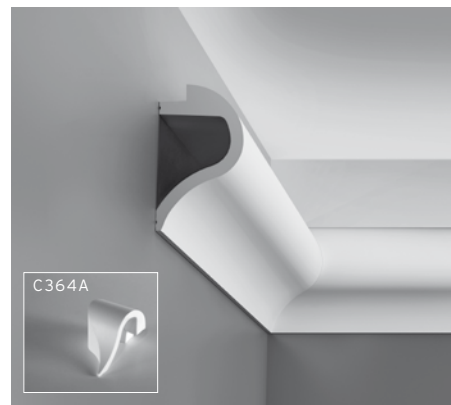
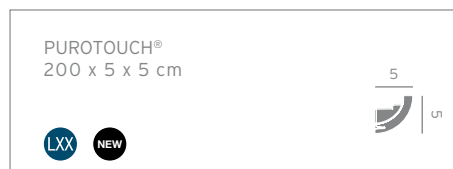

C364 - Designed by Pierre Daems

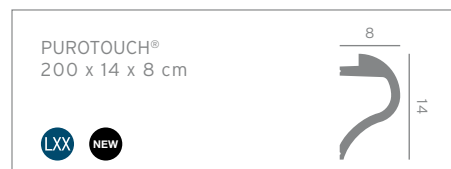

C363 - Designed by Pierre Daems

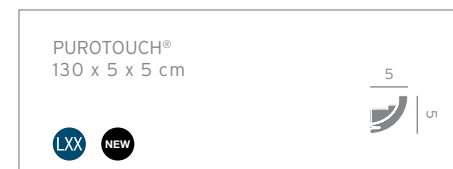



C900

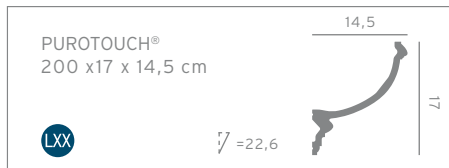

C901

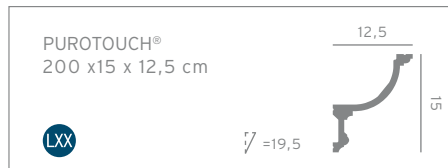

C902

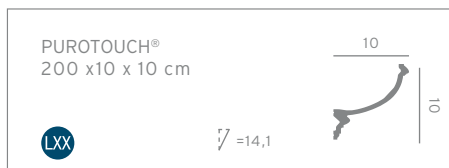

**IL000-001**

5 x pleksi pokrywa C357, L 100cm  
5 x верхний рассеиватель из плексиглаза  
для C357, длина 100cm  
5 x أغطية من زجاج البلكسي لكرانيش  
C357، طول 100 سم

5 x couvertures en plexi pour C357, L 100cm  
5 x plexi cover for C357, L 100cm

**IL000-002**

5 x pleksi pokrywa C358, L 100cm  
5 x верхний рассеиватель из плексиглаза  
для C358, длина 100cm  
5 x أغطية من زجاج البلكسي لكرانيش  
C358، طول 100 سم

5 x couvertures en plexi pour C358, L 100cm  
5 x plexi cover for C358, L 100cm



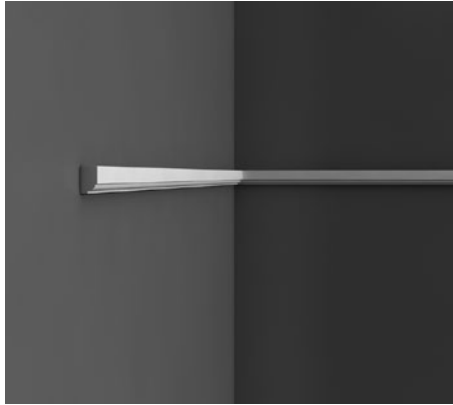

P9050/P9050F

PUROTOUCH®  
200 x 2,5 x 1,5 cm

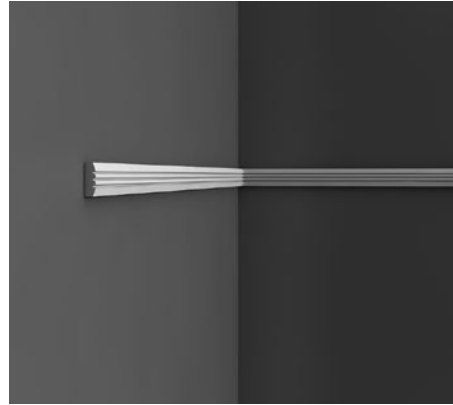

P5021/P5021F

PUROTOUCH®  
200 x 3 x 1 cm

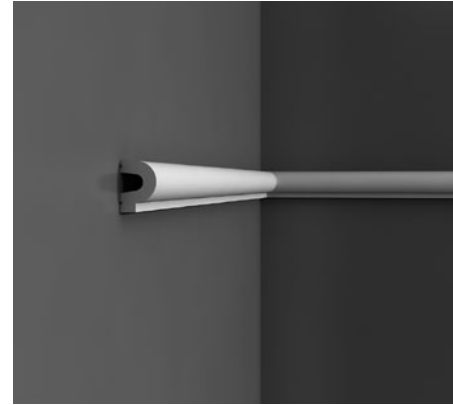

P8060/P8060F

PUROTOUCH®  
200 x 3,5 x 5 cm

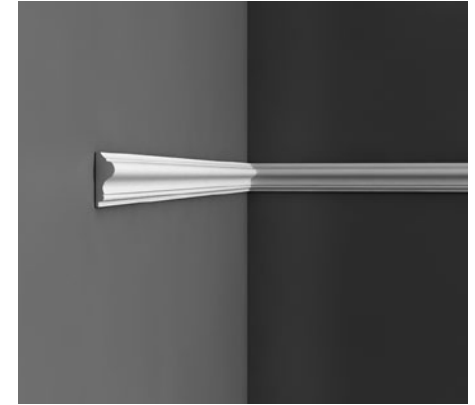

P8030/P8030F

PUROTOUCH®  
200 x 4 x 1,5 cm

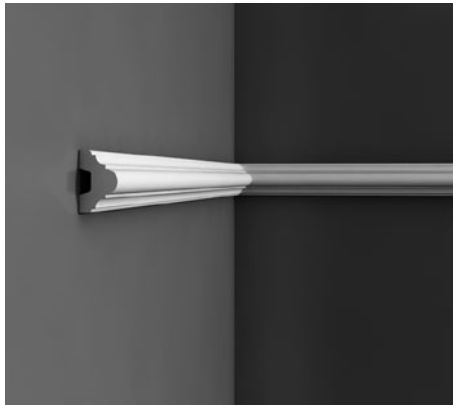

P4020/P4020F

PUROTOUCH®  
200 x 5 x 3 cm

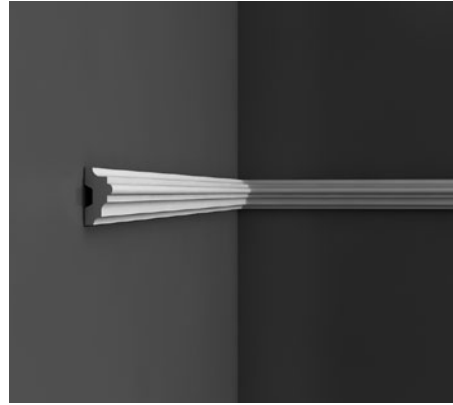

P9040/P9040F

PUROTOUCH®  
200 x 5 x 2,5 cm

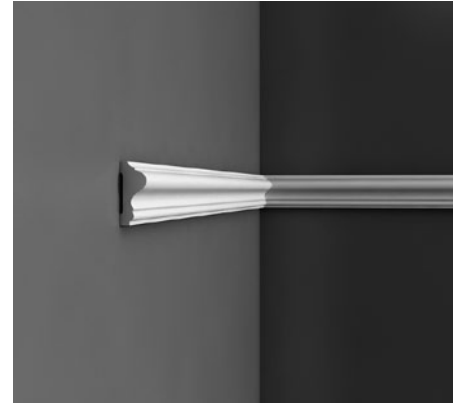

P8020/P8020F

PUROTOUCH®  
200 x 6 x 2,5 cm

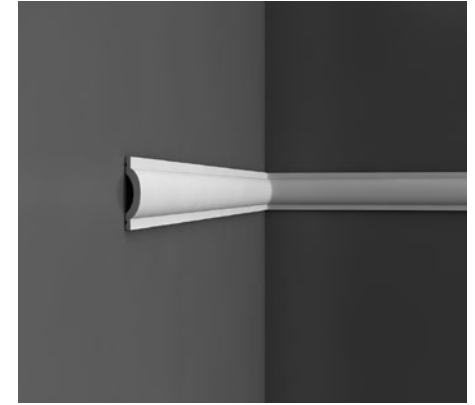

P9901/P9901F

PUROTOUCH®  
200 x 7 x 1,5 cm



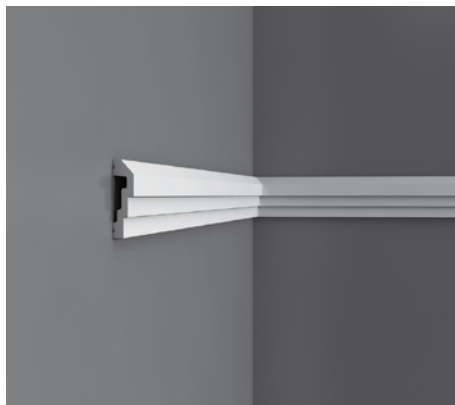

P7070/P7070F

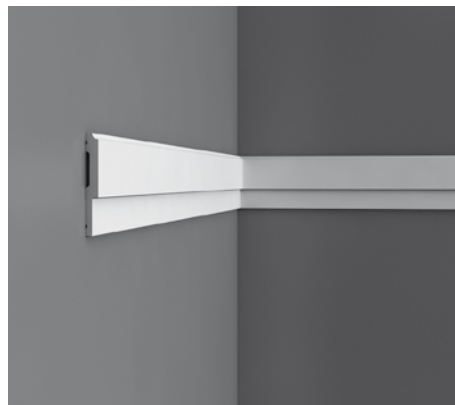
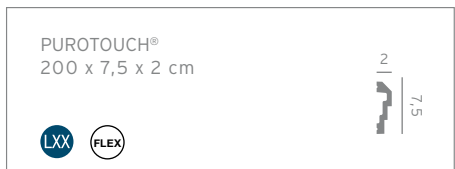

P9900/P9900F

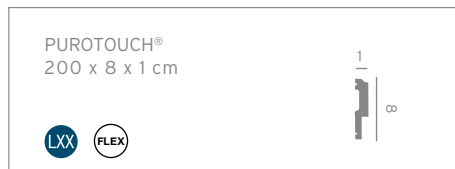

P5051

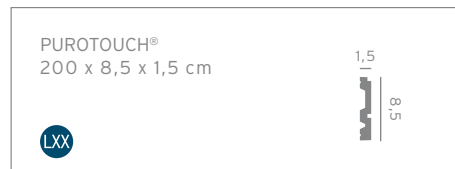

P9010/P9010F

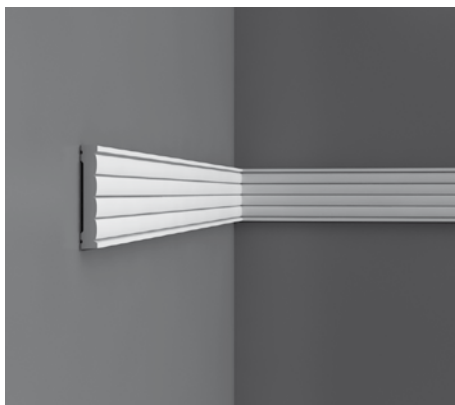
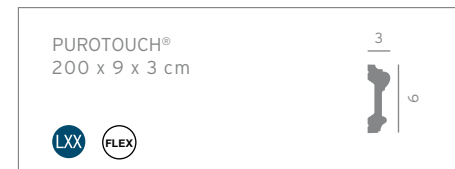

P5020/P5020F

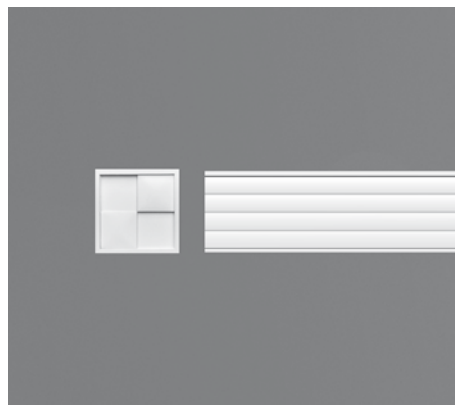
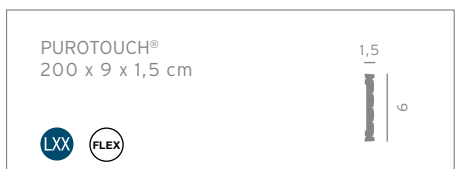

P5020A

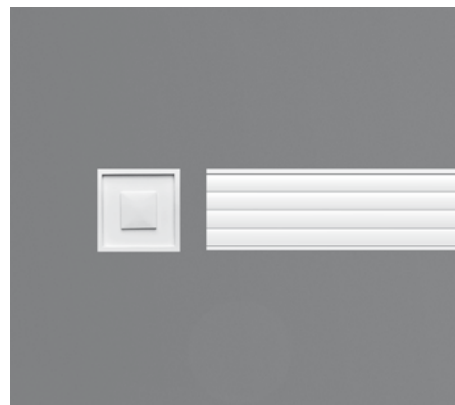
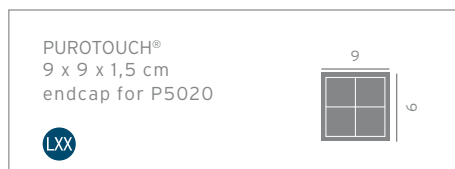

P5020B

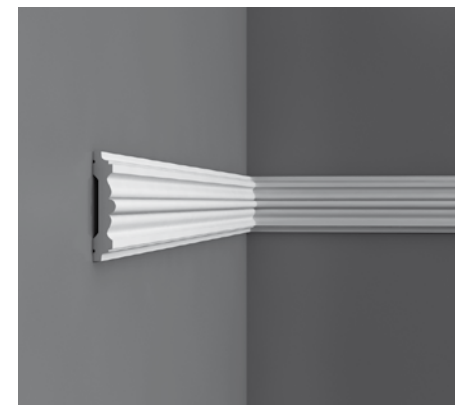
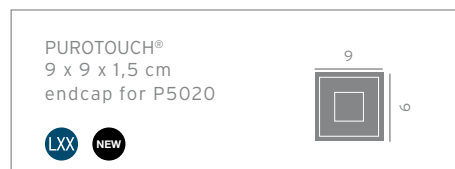

P9020/P9020F

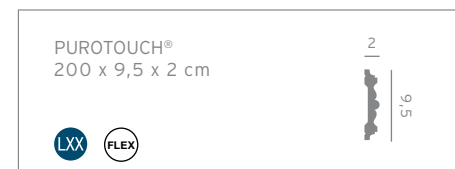

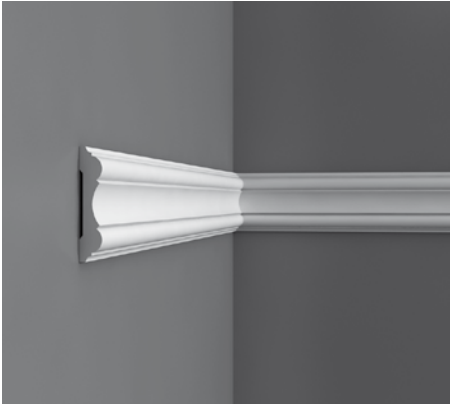

P8040/P8040F

PUROTOUCH®  
200 x 10 x 2 cm

LXX FLEX

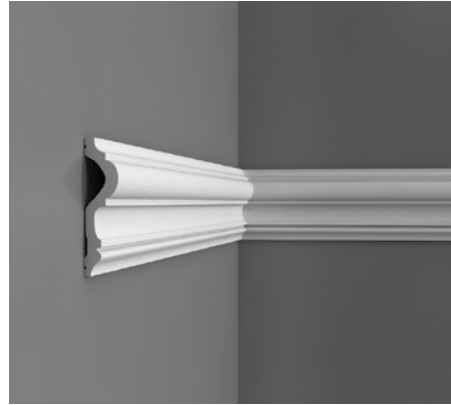

P8050/P8050F

PUROTOUCH®  
200 x 12 x 3 cm

LXX FLEX



P5050

PUROTOUCH®  
200 x 20 x 1,5 cm

LXX



P8030D

DUROPOLYMER®  
13 x 13 x 1,5 cm

LXX



P8030C + P8030

P8030C-DUROPOLYMER®  
19 x 5,5 x 1,5 cm  
P8030-PUROTOUCH®

LXX



P4020A + P4020

PUROTOUCH®  
200 x 5 x 3 cm

LXX



P801C + P8020

PUROTOUCH®  
20 x 8,5 x 2,5 cm

LXX



P4020A

PUROTOUCH®  
16,5 x 7 x 3 cm

LXX



P2020/P2020F

PUROTOUCH®  
200 x 4,5 x 2,5 cm

LXX FLEX

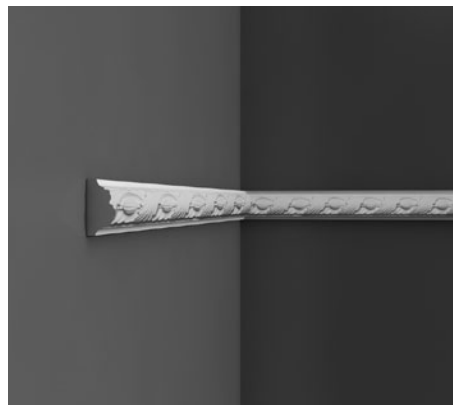

P1020/P1020F

PUROTOUCH®  
200 x 5 x 2,5 cm

LXX FLEX



P7050/P7050F

PUROTOUCH®  
200 x 5,5 x 2,5 cm

LXX FLEX



P3020/P3020F

PUROTOUCH®  
200 x 6 x 3 cm

LXX

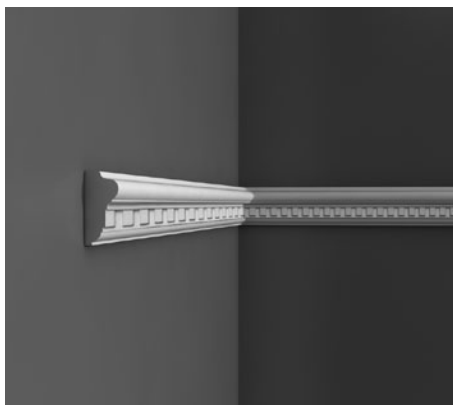

P6020/P6020F

PUROTOUCH®  
200 x 6,5 x 3 cm

LXX FLEX

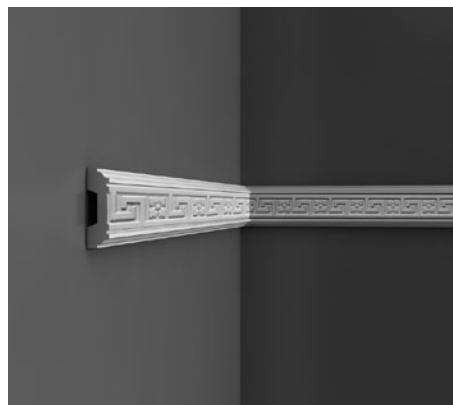

P7060/P7060F

PUROTOUCH®  
200 x 7 x 2 cm

LXX FLEX

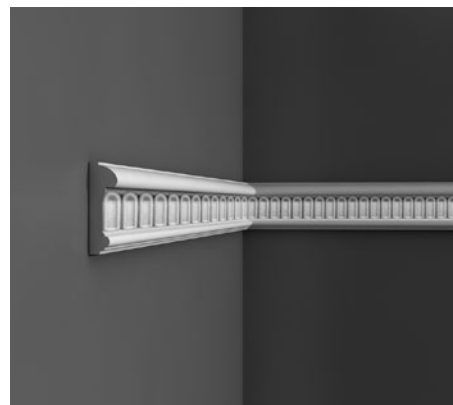

P7040/P7040F

PUROTOUCH®  
200 x 8 x 2,5 cm

LXX FLEX

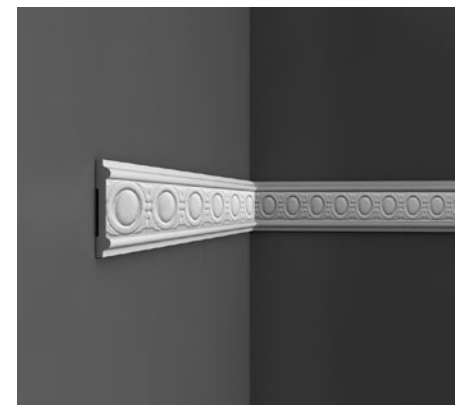

P7030/P7030F

PUROTOUCH®  
200 x 8,5 x 1,5 cm

LXX FLEX



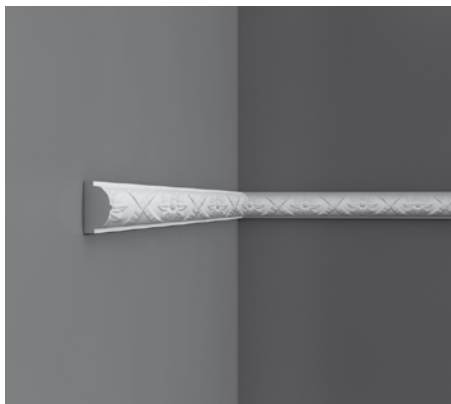

P2020/P2020F

PUROTOUCH®  
200 x 4,5 x 2,5 cm



P21 + P201A

P21-DUROPOLYMER® + P201A-PUROTOUCH®  
P21: 6,5 x 6,5 x 1 cm  
P201A: 20 x 20 x 2,5 cm

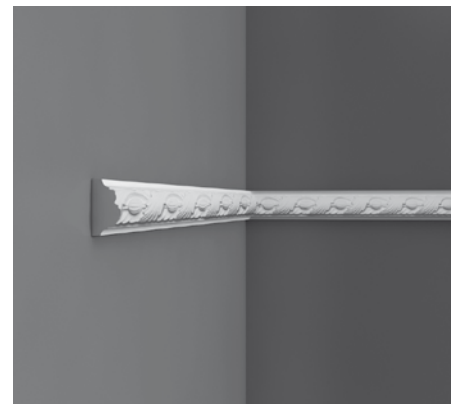

P1020/P1020F

PUROTOUCH®  
200 x 5 x 2,5 cm



P20 + P101A

P20-DUROPOLYMER® + P101A-PUROTOUCH®  
P20: diam. 6,5 cm  
P101: 25 x 25 x 2,5 cm



P7010/P7010F

PUROTOUCH®  
200 x 10,5 x 2 cm



P7020/P7020F

PUROTOUCH®  
200 x 11 x 2 cm



P7080

PUROTOUCH®  
200 x 22 x 2 cm





PX103

DUROPOLYMER®  
200 x 2,5 x 1,5 cm



1,5  
25



PX116

DUROPOLYMER®  
200 x 3 x 1 cm



1  
3

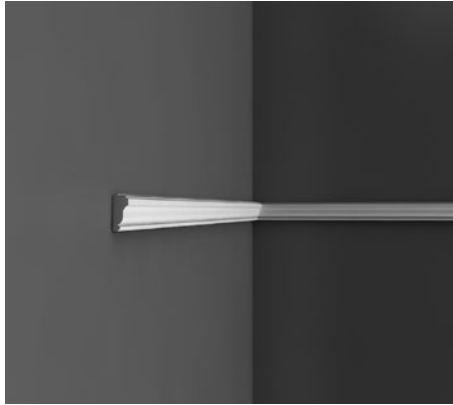

PX117

DUROPOLYMER®  
200 x 3,5 x 1,5 cm

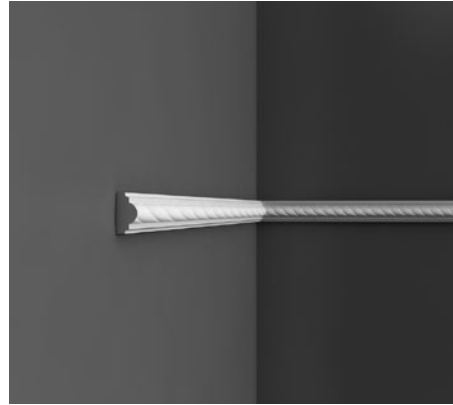

PX131

DUROPOLYMER®  
200 x 4 x 2 cm

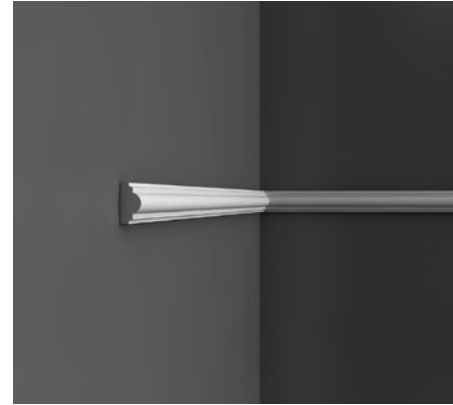

PX120

DUROPOLYMER®  
200 x 4 x 2 cm

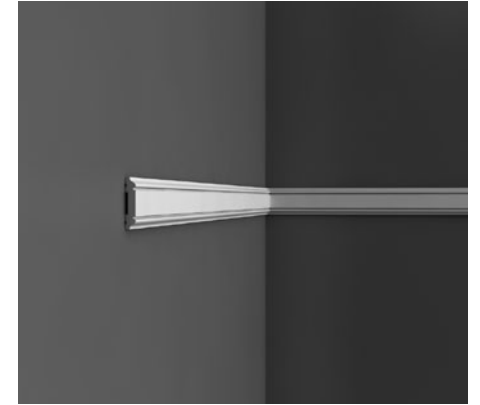

PX144

DUROPOLYMER®  
200 x 5 x 1 cm

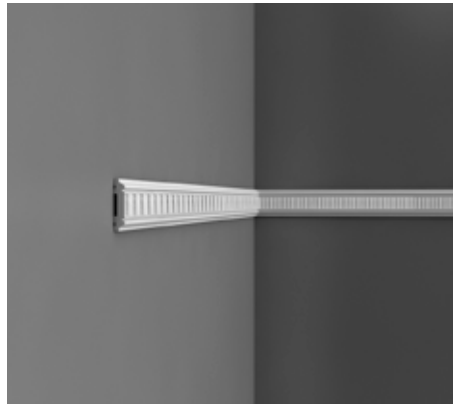

PX145

DUROPOLYMER®  
200 x 5 x 1 cm



PX146

DUROPOLYMER®  
200 x 5 x 1 cm

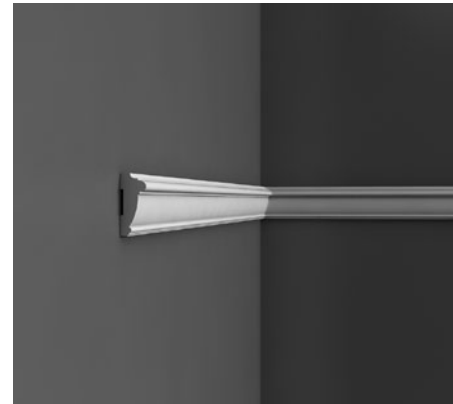

PX113

DUROPOLYMER®  
200 x 6 x 2,5 cm



PX114

DUROPOLYMER®  
200 x 6 x 2,5 cm



PX102

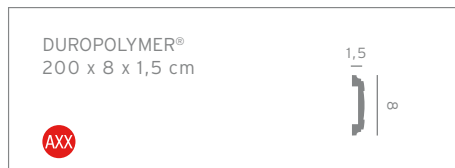

DX162-2300

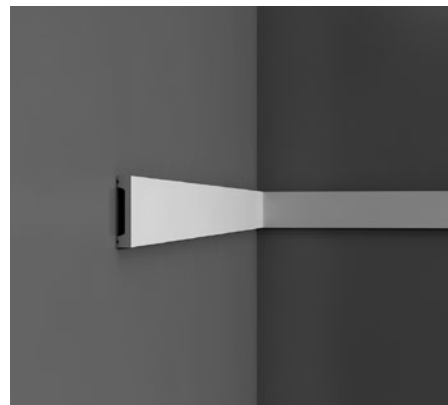
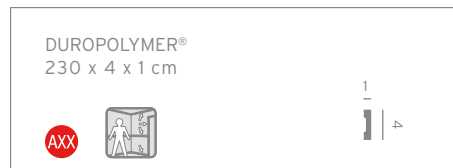

DX157-2300

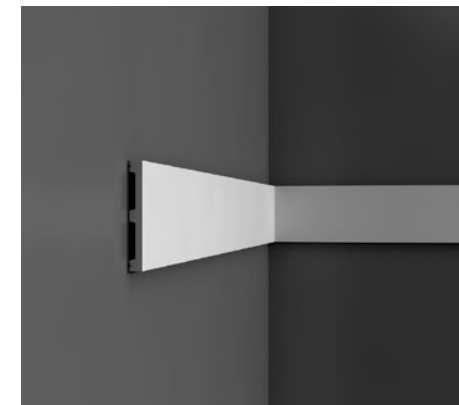
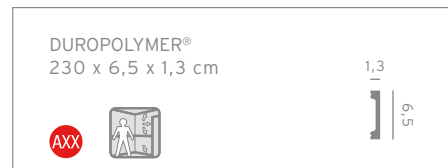

DX163-2300

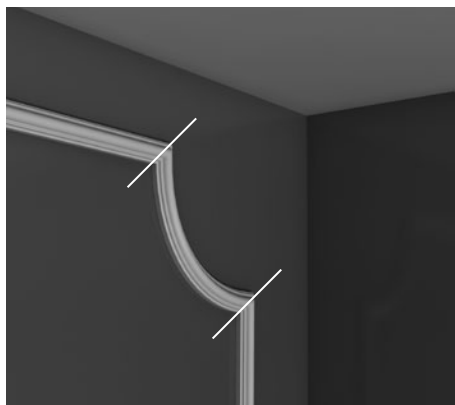
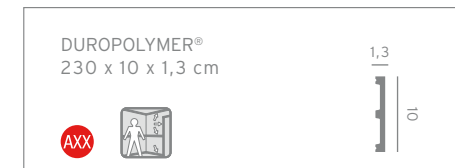

PX103A + PX103

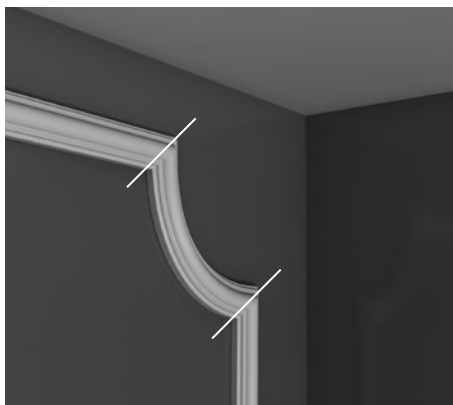
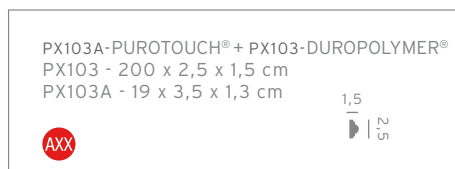

PX120A + PX120

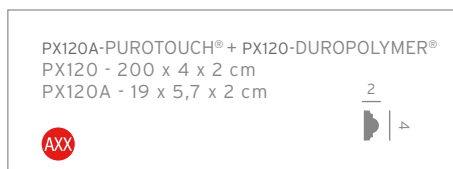

PX164

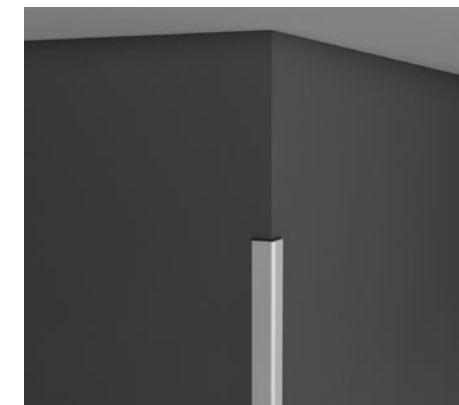
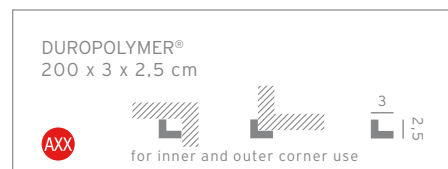

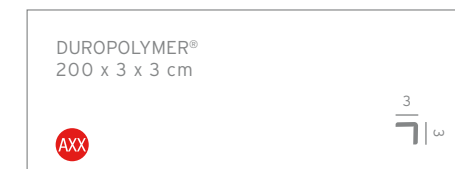

CX134

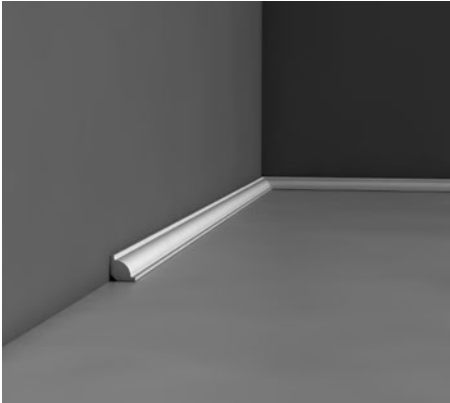



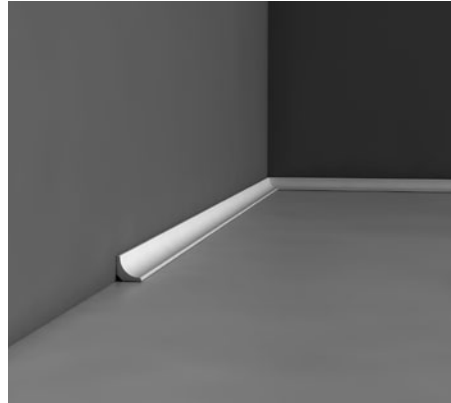

CX132

DUROPOLYMER®  
200 x 2 x 2 cm



CX133

DUROPOLYMER®  
200 x 2 x 2 cm

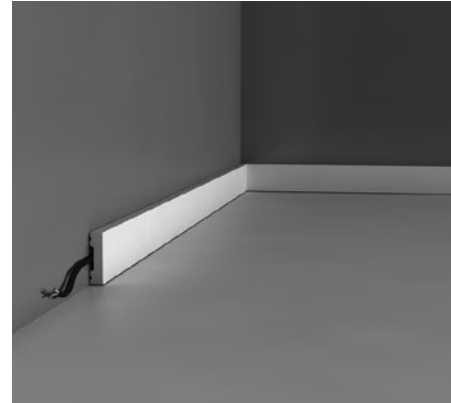

DX162-2300

DUROPOLYMER®  
230 x 4 x 1 cm

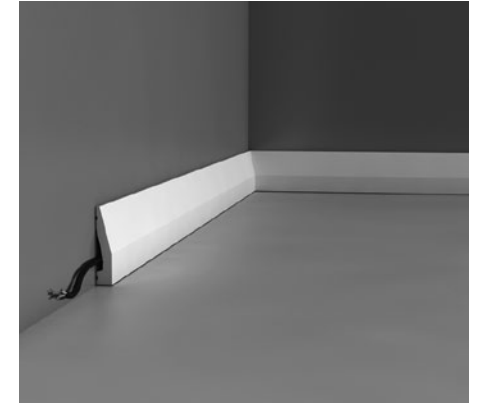

DX159-2300

DUROPOLYMER®  
230 x 6 x 1,2 cm

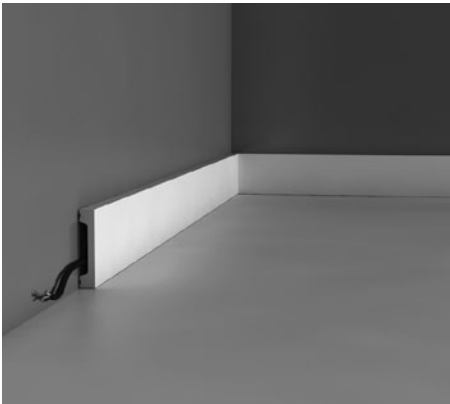

DX157-2300

DUROPOLYMER®  
230 x 6,5 x 1,3 cm



SX125

DUROPOLYMER®  
200 x 7 x 1,5 cm



SX122

200 x 8 x 2,2 cm

SX137

DUROPOLYMER®  
200 x 10 x 1,5 cm

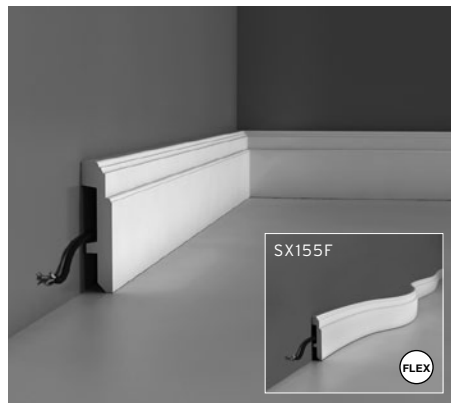

SX155

DUROPOLYMER®  
200 x 11 x 2,5 cm

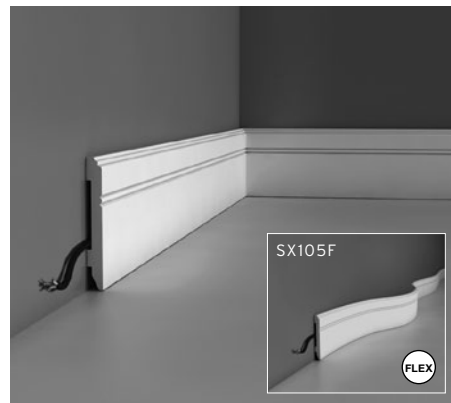

SX105

DUROPOLYMER®  
200 x 11 x 1,3 cm

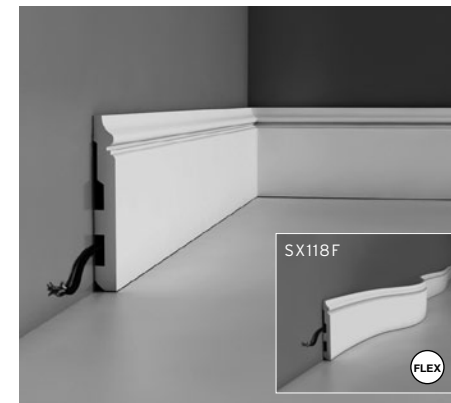

SX118

DUROPOLYMER®  
200 x 14 x 1,8 cm

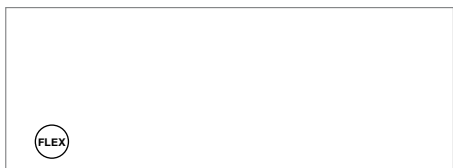

SX138

DUROPOLYMER®  
200 x 14 x 1,5 cm



SX104

DUROPOLYMER®  
200 x 15 x 1,5 cm



SX156 - Designed by Xavier Donck

DUROPOLYMER®  
200 x 20 x 1,6 cm

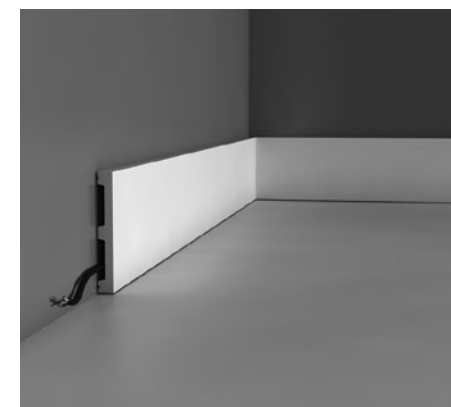

DX163-2300

DUROPOLYMER®  
230 x 10 x 1,3 cm



DRINK  
*Coca-Cola*  
ICE COLD

Orac Flex



Orac Flex

Gzymusy / Карнизы / کرانیس /  
Corniches / Cornice Mouldings

	Rmin	R*min
C200F	1,2 m	
C201F	1,6 m	/
C211F	2,5 m	/
C212F	1,4 m	/
C213F	1,8 m	/
C214F	1,0 m	/
C215F	1,6 m	/
C216F	3,4 m	/
C217F	3,4 m	/
C218F	3,5 m	/
C220F	2,0 m	/
C230F	1,0 m	/
C240F	2,0 m	/
C250F	0,8 m	/
C260F	1,3 m	/
C301F	3,0 m	/
C302F	2,6 m	/
C303F	1,8 m	/
C304F	1,8 m	/
C305F	3,4 m	/
C308F	1,4 m	/
C321F	1,4 m	/
C322F	1,2 m	/
C331F	4,2 m	/
C333F	3,3 m	/
C334F	3,8 m	/
C339F	2,4 m	/
C402F	1,5 m	/
C602F	1,3 m	/
C901F	3,8 m	/
C902F	3,8 m	/

Profile dekoracyjne / Молдинги  
قوالب للجدران / Cimaises / Panel Mouldings

	Rmin	R*min
P1020F	0,4 m	1,2 m
P2020F	0,4 m	1,2 m
P3020F	0,8 m	1,8 m
P4020F	0,4 m	1,4 m
P5020F	0,4 m	/
P5021F	0,3 m	0,8 m
P6020F	0,4 m	2,0 m
P7010F	0,3 m	/
P7020F	0,3 m	/
P7030F	0,3 m	/
P7040F	0,5 m	/
P7050F	0,5 m	/
P7060F	0,4 m	/
P7070F	0,4 m	/
P8020F	0,5 m	2,0 m
P8030F	0,3 m	1,0 m
P8040F	0,3 m	/
P8050F	0,8 m	1,8 m
P8060F	0,8 m	2,0 m
P9010F	0,4 m	/
P9020F	0,4 m	/
P9040F	0,4 m	0,9 m
P9050F	0,3 m	1,0 m
P9900F	0,4 m	1,8 m
P9901F	0,4 m	1,8 m

Listwy przypodłogowe / Плинтус /  
نعلات / Plinthes / Skirting

	Rmin	R*min
SX105F	0,4 m	/
SX118F	0,4 m	/
SX155F	0,4 m	/

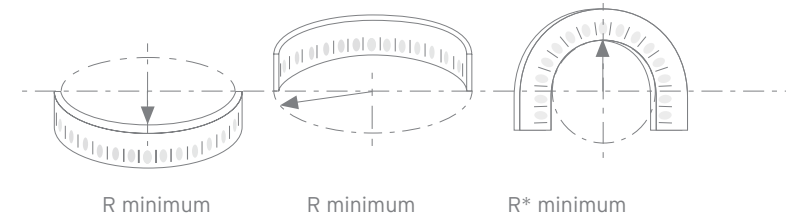

PO

ORAC FLEX, ELEGANCKIE ROZWIĄZANIE DLA WYGIĘTYCH LUB ZAOKRĄGLONYCH ŚCIAN.

Orac luxxus zapewnia szeroki zakres gzymsów, profili dekoracyjnych i listew przypodłogowych, które mogą być również wykonane z elastycznego poliuretanu. Dzięki elastyczności tego materiału możliwe jest teraz eleganckie dekorowanie zaokrąglonych ścian i sufitów. Te gzymsy i profile dekoracyjne mogą być instalowane i wykańczane przy użyciu tych samych metod, jak przy normalnych poliuretanowych profilach. Instrukcje montażu są dostępne.

RU

ГИБКИЕ МОДЕЛИ ORAC FLEX - ЭТО ЭЛЕГАНТНОЕ РЕШЕНИЕ ДЛЯ СТЕН С ЗАКРУГЛЕННОЙ ГЕОМЕТРИЕЙ. Все карнизы и панели молдингов коллекции Orac Luxxus могут быть также изготовлены из полиуретана в гибком виде. Любая изогнутая или закругленная стена может быть красиво отделана гибкими моделями, благодаря свойствам гибкости материала. Гибкие модели монтируются так же, как и жесткие модели, инструкция прилагается.

AR

أوراك فليكس: الحل الأنيق للجدران المستديرة و المقوسة

هذه لمحة عامة عن کرانیس، قوالب جدران ونعلات أوراك لوکسس التي تصنع أيضا من بوليوريثين مرن. بفضل مرونتها، يمكن أن تستعمل هذه الأصناف لتزيين الجدران والسقوف المقوسة. يمكن طلاء هذه القوالب مثل تلك المصنوعة من بوليوريثين عادي. تعليمات التركيب متوفرة.

FR

ORAC FLEX, LA SOLUTION ÉLÉGANTE POUR LES MURS CINTRÉS ET ARRONDIS

Voici un aperçu des corniches, cimaises et plinthes Orac Luxxus existantes qui sont réalisées dans un polyuréthane flexible. Par leur souplesse, elles permettent de décorer les murs et plafonds arrondis. Ces moulures peuvent être décorées de la même façon que les autres moulures. Des modes d'emploi sont disponibles.

EN

ORAC FLEX, THE ELEGANT SOLUTION FOR ROUNDED AND CURVED WALLS

Please find hereby an overview of all Luxxus cornices, panel mouldings and skirting boards which can also be made out of flexible polyurethane. Thanks to the flexibility of this material, it is now possible to decorate rounded walls and ceilings elegantly. These cornice and wall mouldings can be finished using the same methods as with the normal polyurethane mouldings. Installation instructions are available.



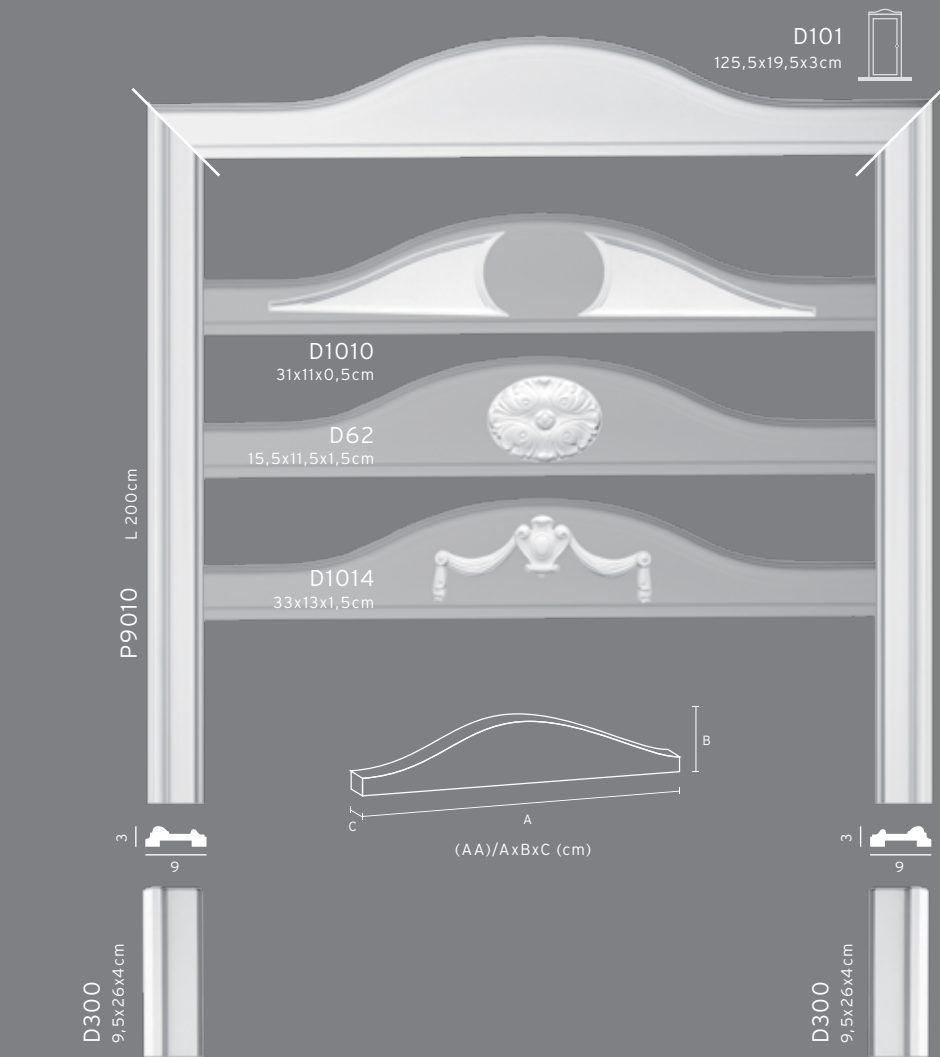

D210  
9,5x9,5x3cm



DX121-2300

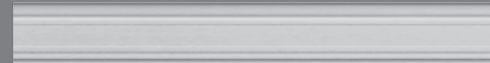

L 230cm



D200  
9,5x9,5x3cm



D310  
9,5x25x3cm

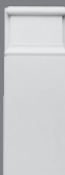

DX119-2300  
L 230cm



DX121-2300  
L 230cm



D310  
9,5x25x3cm



DX119-2300  
L 230cm



KITS

kit KX001

- 1 x DX119, L 107cm
- 2 x DX119, L 213 cm
- 2 x D200 (9,5 x 9,5 x 3 cm)

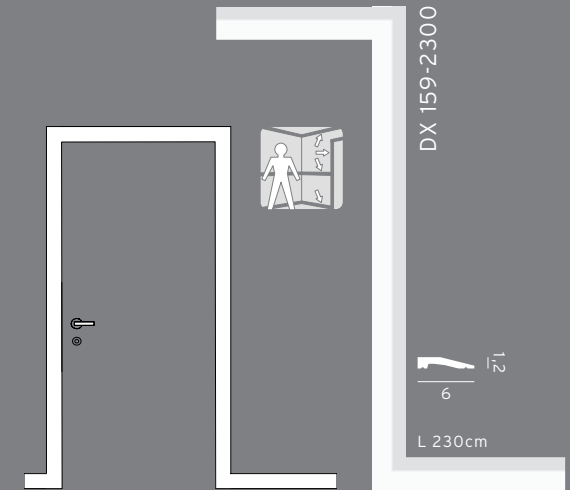
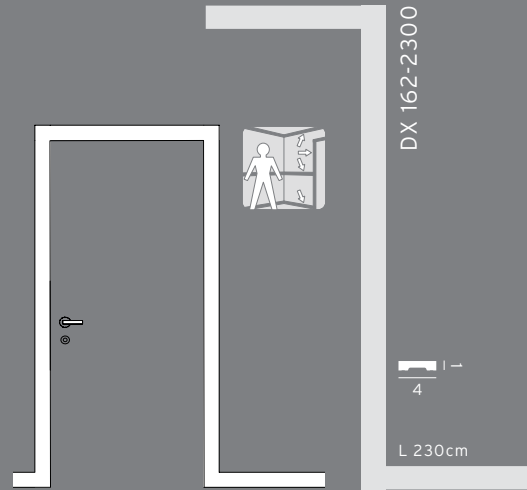

kit KX003

- 1 x DX119, L 107cm
- 2 x DX119, L 190 cm
- 2 x D200 (9,5 x 9,5 x 3 cm)
- 2 x D310 (9,5 x 25 x 3 cm)

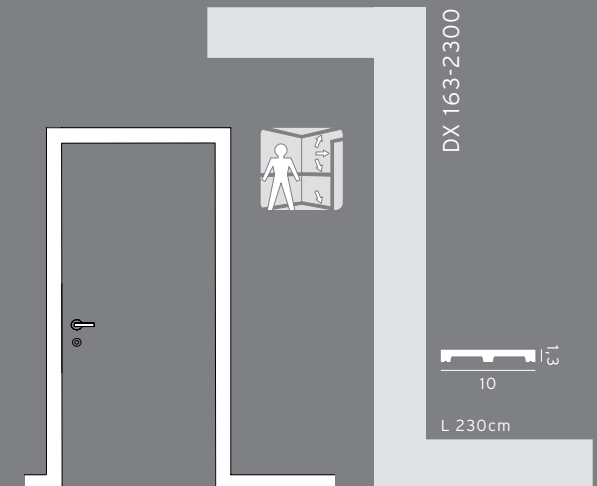
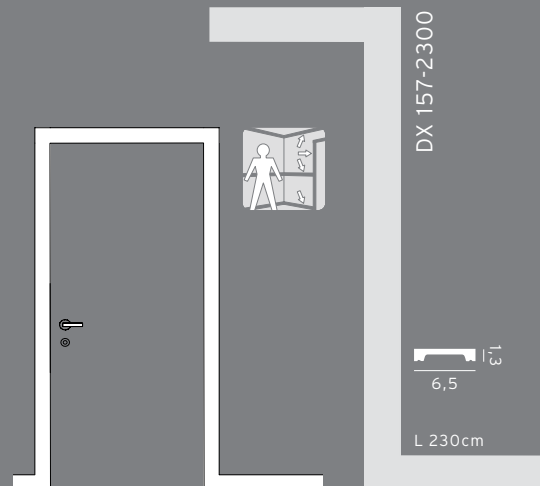



D140  
PUROTOUCH®  
99 x 32 x 2 cm

LXX



D120  
PUROTOUCH®  
124/113 x 25 x 9 cm

LXX



D150  
PUROTOUCH®  
100,5 x 15,5 x 1,5 cm

LXX



D400  
PUROTOUCH®  
127,5/122 x 14,5 x 5,5 cm

LXX



D161  
PUROTOUCH®  
92 x 21,5 x 4 cm

LXX



D401  
PUROTOUCH®  
127,5/122 x 14,5 x 5,5 cm

LXX



D170  
PUROTOUCH®  
105 x 25 x 3,5 cm

LXX



D402  
PUROTOUCH®  
12,7 x 14,5 x 6 cm  
(only for D400 and D401)

LXX



D400 + D402  
PUROTOUCH®  
127,5/122 x 14,5 x 5,5 cm

LXX



2 x D401 + D402  
PUROTOUCH®  
max. 245,5/240 x 14,5 x 5,5 cm

LXX

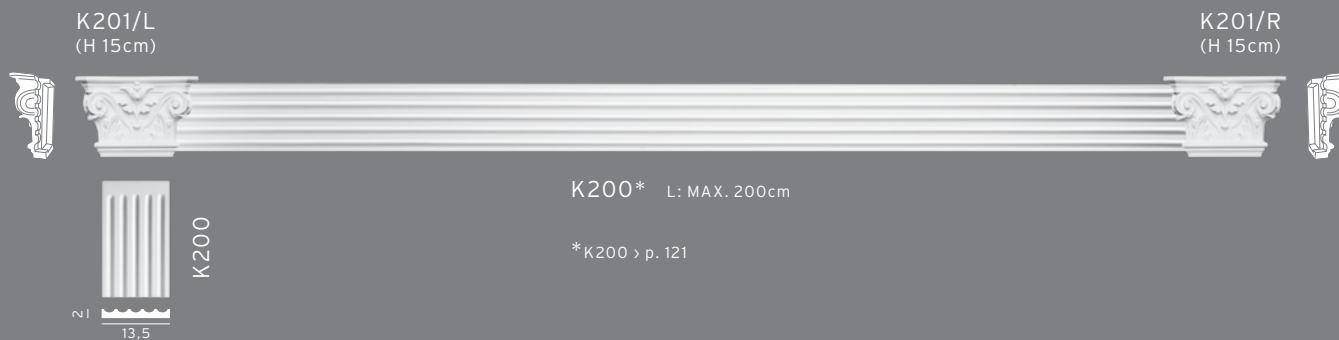

K201/L  
(H 15cm)

K201/R  
(H 15cm)

K200\* L: MAX. 200cm

\*K200 > p. 121

13,5

K200

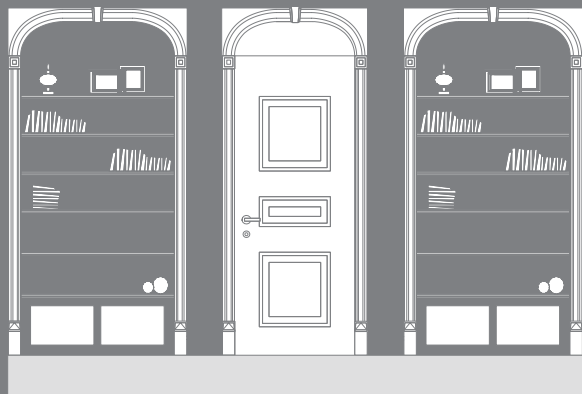

M9010L, M9010A, M9010R  
D200, P9010, D300, D503, D504, SX118  
DUROPOLYMER®

LXX

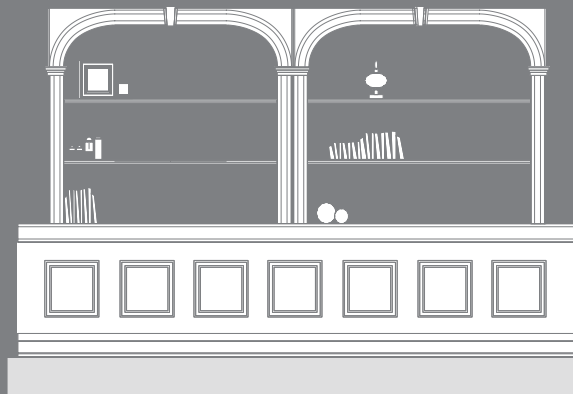

M9010L, M9010A, M9010R, M9010B, M9010C  
P9010, P9020, D506, SX105  
DUROPOLYMER®

LXX

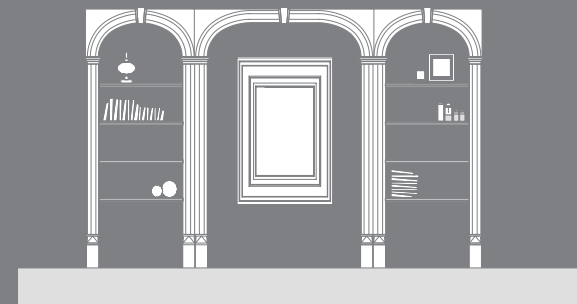

M9010L, M9010A, M9010R, M9010B, M9010C  
P9010, D300  
DUROPOLYMER®

LXX



M9010L, M9010A, M9010R  
K200, K201, D320, P9010  
DUROPOLYMER®

LXX

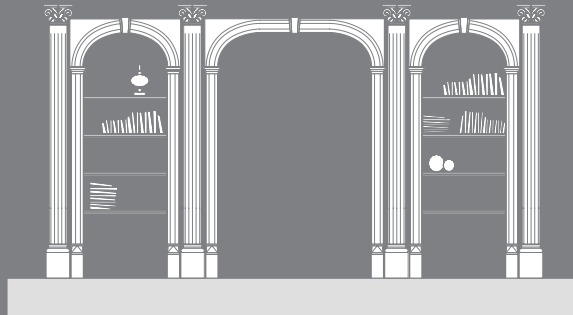

M9010L, M9010A, M9010R, M9010B, M9010C  
K201, K200, K202, P9010, D300  
DUROPOLYMER®

LXX



M9010L, M9010A, M9010R, M9010B  
P9010  
DUROPOLYMER®

LXX

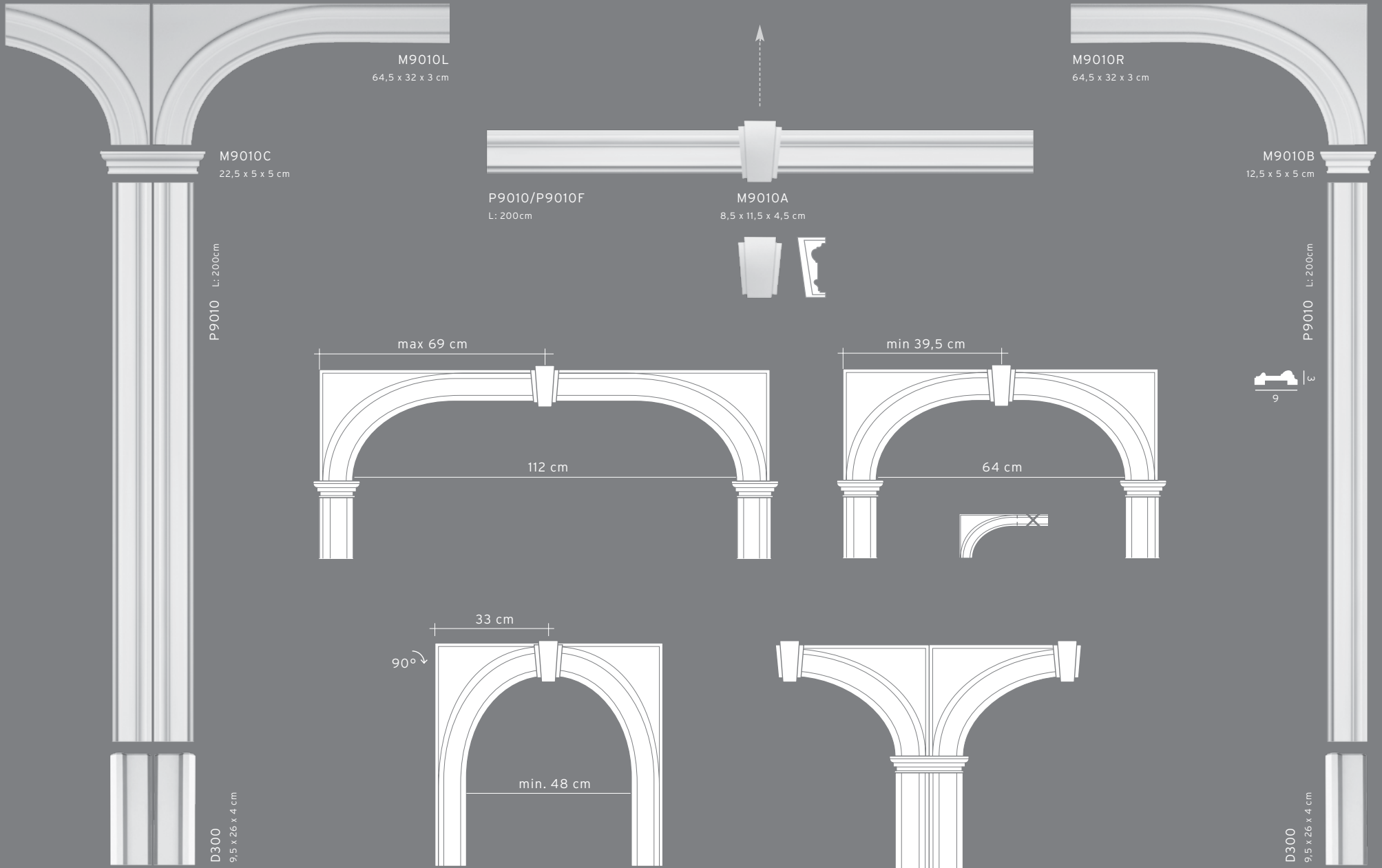



D500  
DUROPOLYMER®  
55 x 75 x 1,5 cm

LXX

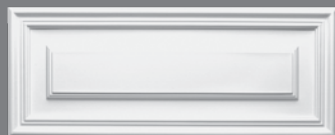

D504  
DUROPOLYMER®  
55 x 22 x 1,5 cm

LXX



D503  
DUROPOLYMER®  
55 x 55 x 1,5 cm

LXX



D507  
DUROPOLYMER®  
55 x 90,5 x 1,5 cm

LXX



D506  
DUROPOLYMER®  
43 x 43 x 1,5 cm

LXX

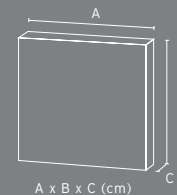

F30  
PUROTOUCH®  
60,5 x 60,5 x 4 cm

LXX



F31  
PUROTOUCH®  
59,5 x 59,5 x 6,5 cm

LXX



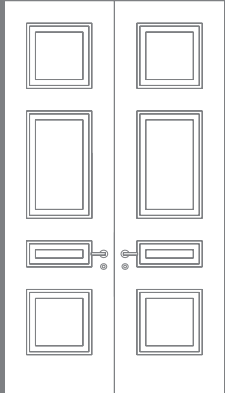

D503, D504

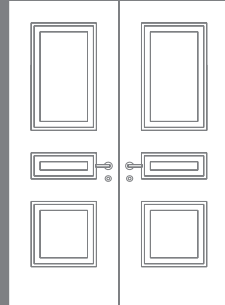

D507, D503, D504



DX121  
D503, D507

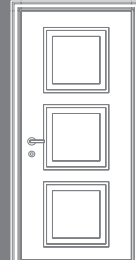

DX119  
D503



D310

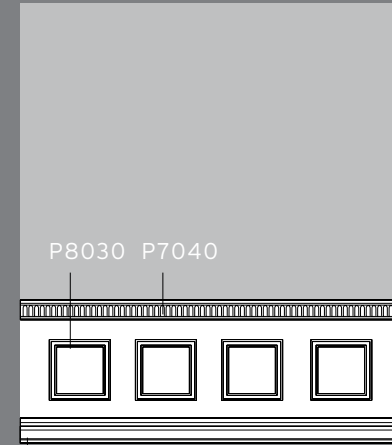

SX118  
DX121-2300

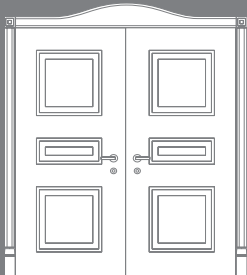

D310

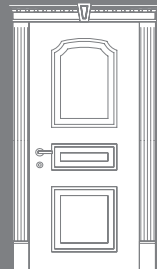

D320



D320

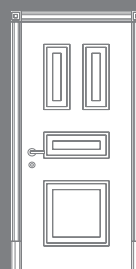

D300

D200, D102, D503, D504



D401, D402, K200  
D500, D504, D503



K201L, K200, K201R  
D504, D507



D200, P9010, D310  
D504, D503, D507



DX119-2300

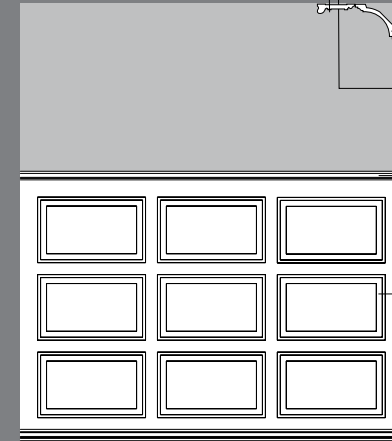

C217

C200

P8020





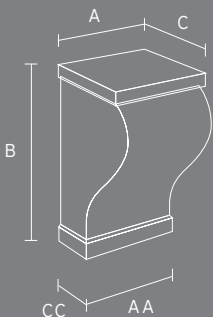

A x B x C (cm)  
AA x CC (cm)

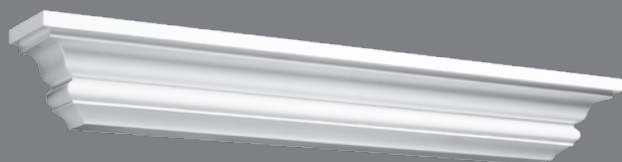

B417  
PUROTOUCH®  
90,5 x 13,5 x 14 cm

LXX



B408  
PUROTOUCH®  
22,5 x 40 x 13 cm

LXX



B404  
PUROTOUCH®  
19,5 x 31,5 x 11,5 cm

LXX



B403  
PUROTOUCH®  
19 x 19 x 10 cm

LXX



B402  
PUROTOUCH®  
9 x 22 x 7 cm

LXX



B401  
PUROTOUCH®  
11,5 x 15,5 x 7 cm

LXX



B409  
PUROTOUCH®  
30 x 35 x 17,5 cm

LXX



B413  
PUROTOUCH®  
16 x 22,5 x 8,5 cm

LXX



B414  
PUROTOUCH®  
10 x 22 x 7 cm

LXX



B410  
PUROTOUCH®  
19,5 x 50 x 16 cm

LXX



H100  
PUROTOUCH®  
114,5 x 129,5 x 20,5 cm

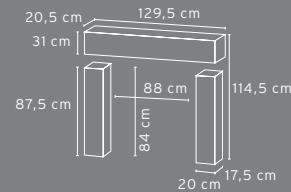

H101  
PUROTOUCH®  
110 x 129 x 20 cm

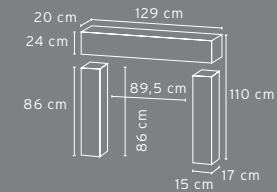

max. 2 à 3 kW

Kominki są tylko dekoracyjną propozycją i powinny być instalowane tylko w połączeniu z wkładem elektrycznym o mocy 2 do 3 kW.  
Камины являются только декоративными элементами. Они используются только для электрических каминов, макс. мощность 2-3 кВт.  
Les cheminées sont **des éléments décoratifs**. Elles peuvent seulement être employées avec un feu électrique de max. 2 à 3 kW.  
The fireplaces are **just as decorative purposes** and should only be installed in conjunction with an electric heater up to 2 to 3 kW.  
المواقد هي زينية فقط ويجب إستعمالها مع شعلة كهربائية لا تزيد عن ٢ إلى ٣ كيلوات



Elementy Dekoracyjne / Декоративные элементы  
 أصناف للزينة / Éléments Décoratifs / Deco Elements

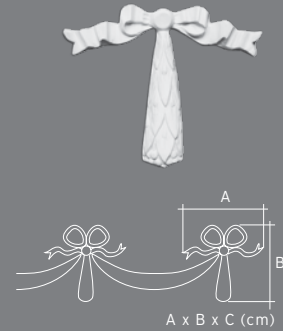

G40  
 DUROPOLYMER®  
 17 x 14 x 1,5 cm



G42  
 DUROPOLYMER®  
 40 x 4,5 x 1,5 cm



G50  
 PUROTOUCH®  
 54 x 39 x 3 cm



G51  
 PUROTOUCH®  
 73,5 x 9,5 x 3 cm





N403 / N404 / N410  
PUROTOUCH®  
N403 - 43 x 70,5 x 10 cm  
N404 - 42 x 76 x 11 cm  
N410 - 31 x 59,5 x 9,5 cm



LXX



N503 / N504 / N510 / N520  
PUROTOUCH®  
N503 - 69 x 112,5 x 11 cm  
N504 - 69 x 113 x 11 cm  
N510 - 55 x 98,5 x 18 cm  
N520 - 55 x 97,5 x 18 cm



LXX



N504 + N510  
PUROTOUCH®  
N504 - 69 x 113 x 11 cm  
N510 - 55 x 98,5 x 18 cm

LXX



N504 + N520  
PUROTOUCH®  
N504 - 69 x 113 x 11 cm  
N520 - 55 x 97,5 x 18 cm

LXX

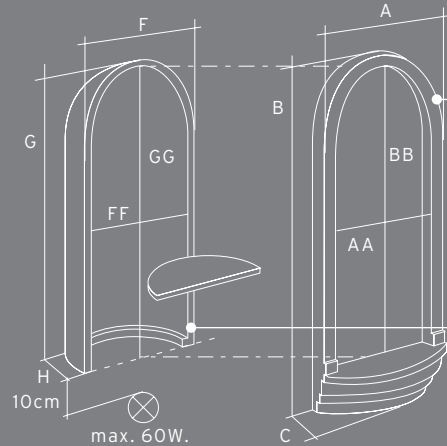

(cm)	A	B	C	AA	BB
N403	43,0	70,5	10,0	26,5	55,0
N404	42,0	76,0	11,0	24,5	55,0
N503	69,0	112,5	11,0	51,5	94,5
N504	69,0	113,0	11,0	49,5	94,5

(cm)	F	G	H	FF	GG
N410	31,0	59,5	9,5	28,0	58,5
N510	55,0	98,5	18,0	53,0	96,0
N520	55,0	97,5	18,0	53,0	92,0



N503 + N510  
PUROTOUCH®  
N503 - 69 x 112,5 x 11 cm  
N510 - 55 x 98,5 x 18 cm

LXX



N503 + N520  
PUROTOUCH®  
N503 - 69 x 112,5 x 11 cm  
N520 - 55 x 97,5 x 18 cm

LXX

Miejsce Żarówki (max. 60W) co najmniej 10 cm.

Устанавливать лампочку (макс. Мощность 60Вт) на расстоянии не менее 10 см. от оргстекла ниши

Installez l'ampoule (max. 60W) à 10cm minimum du fond opaque.

Place the bulb (max. 60W) at least 10cm of soil opal.

تركب اللمبة (٦٠ واط كحد أقصى) على مسافة ١٠ سم على الأقل من الأسفل

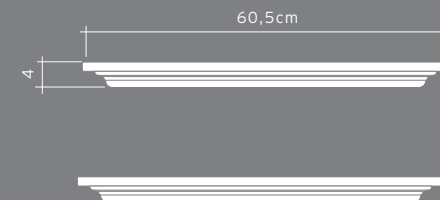

F30  
PUROTOUCH®  
60,5 x 60,5 x 4 cm\*  
\*59,5 x 59,5 x 4 cm > [info@oracdecor.com](mailto:info@oracdecor.com)

LXX



F31  
PUROTOUCH®  
59,5 x 59,5 x 6,5 cm

LXX

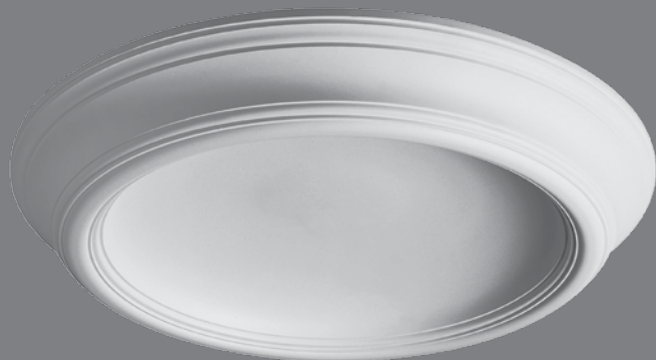

F10  
PUROTOUCH®  
11 x max. diam. 89,5

LXX

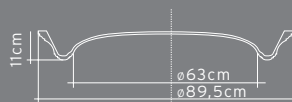

F11  
PUROTOUCH®  
9,5 x max. diam. 74,5

LXX

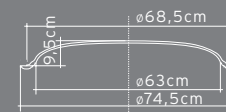

F12  
PUROTOUCH®  
33 x max. diam. 132

LXX

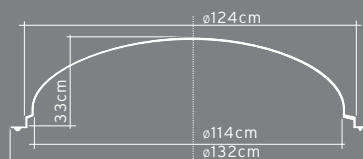

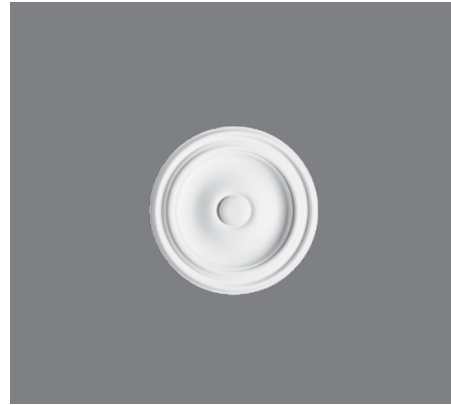
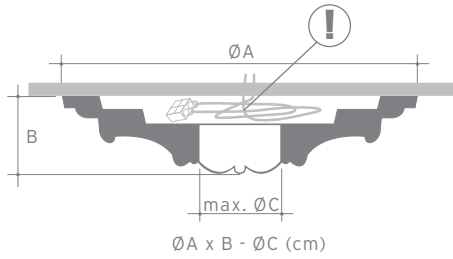

R07

PUROTOUCH®  
Ø26 x 2,5 - Ø5cm



R08

PUROTOUCH®  
Ø38 x 3,5 - Ø5cm

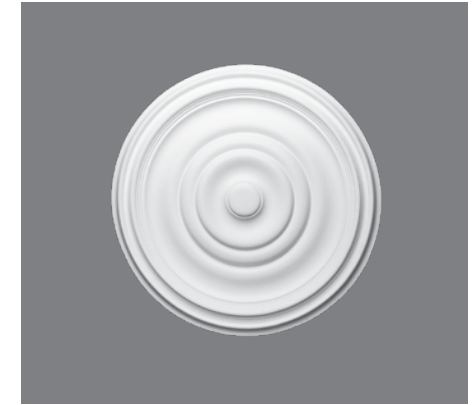

R09

PUROTOUCH®  
Ø48,5 x 4 - Ø6cm



R66

PUROTOUCH®  
Ø54,5/43 x 3,5



R76

PUROTOUCH®  
Ø62 x 4 - Ø10,5cm



R40

PUROTOUCH®  
Ø74,5 x 3,5 - Ø10cm



R35

PUROTOUCH®  
Ø22 x 3





R10

PUROTOUCH®  
Ø15 x 4 - Ø2cm



R11

PUROTOUCH®  
Ø19 x 4 - Ø3cm



R12

PUROTOUCH®  
Ø20 x 2 - Ø1cm



R13

PUROTOUCH®  
Ø28,5 x 3,5 - Ø2,5cm



R50

PUROTOUCH®  
Ø32 x 4 - Ø19cm



R14

PUROTOUCH®  
Ø33,5 x 3 - Ø2,5cm



R31

PUROTOUCH®  
Ø38,5 x 3 - Ø3,5cm



R61

PUROTOUCH®  
Ø40 x 2,5 - Ø2,5cm





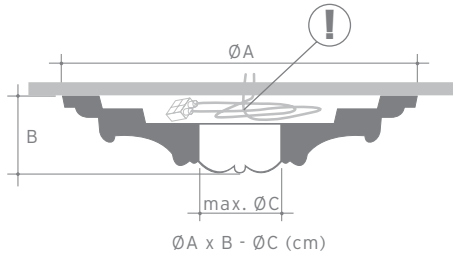

R16

PUROTOUCH®  
Ø45 x 4 - Ø3cm



R17

PUROTOUCH®  
Ø47 x 3,5 - Ø6,5cm



R18

PUROTOUCH®  
Ø49 x 5 - Ø7cm



R46

PUROTOUCH®  
Ø53,5 x 4 - Ø3cm



R22

PUROTOUCH®  
(77 x 52,5) x 4cm



R77

PUROTOUCH®  
Ø62 x 4,5 - Ø10,5cm



R74

PUROTOUCH®  
Ø65,5 x 4 - Ø8cm





R52

PUROTOUCH®  
Ø69,5 x 3,5 - Ø12,5cm



R38

PUROTOUCH®  
Ø71 x 4,5 - Ø19cm

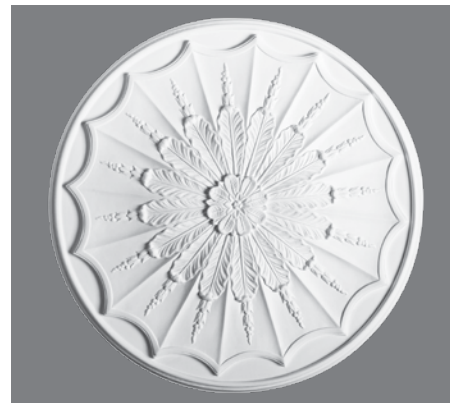

R28

PUROTOUCH®  
Ø68,5 x 3,5 - Ø2cm



R73

PUROTOUCH®  
Ø70 x 4 - Ø8cm



R23

PUROTOUCH®  
Ø71,5 x 4 - Ø6cm



R27

PUROTOUCH®  
Ø75 x 4,5 - Ø9cm



R24

PUROTOUCH®  
Ø79 x 4 - Ø8cm



R64

PUROTOUCH®  
Ø95,5 x 8 - Ø7cm





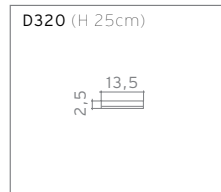
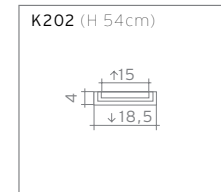
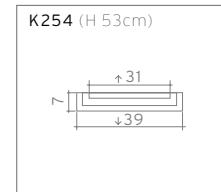
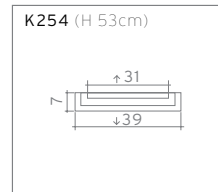
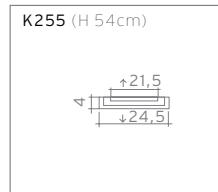
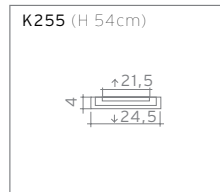
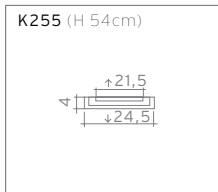
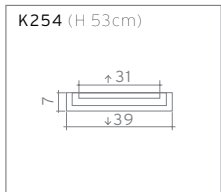
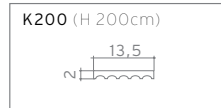
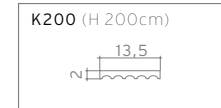
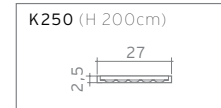
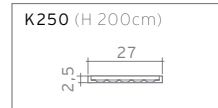
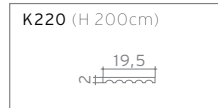
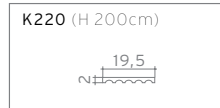
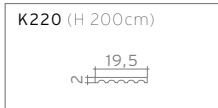
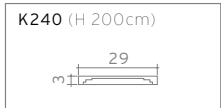
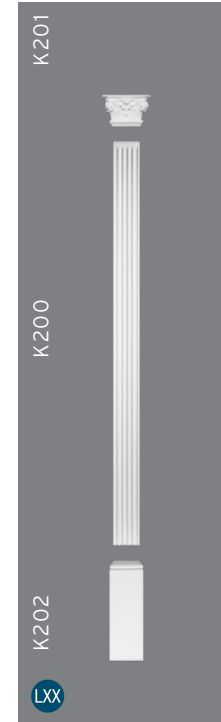
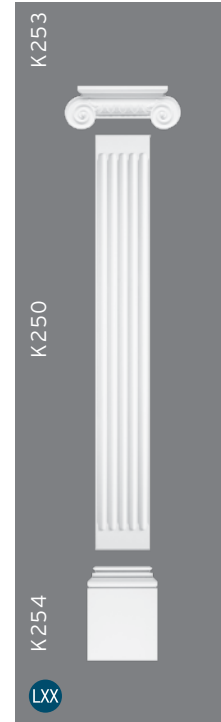
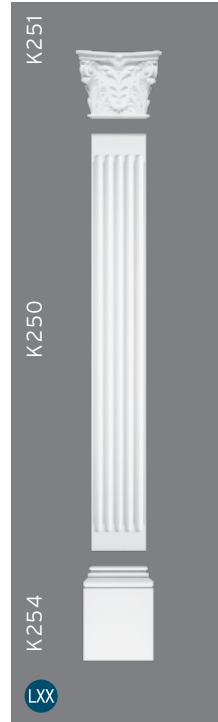
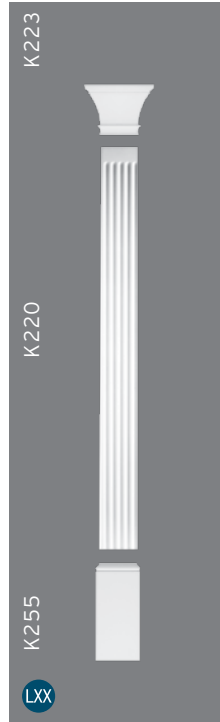
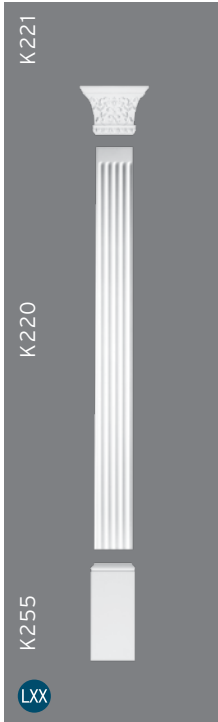
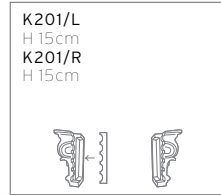
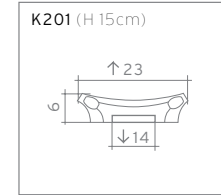
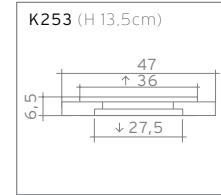
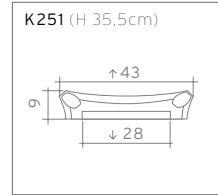
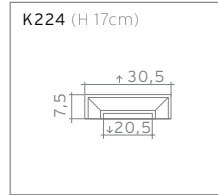
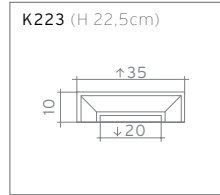
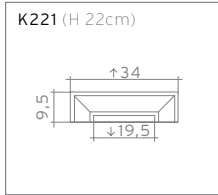
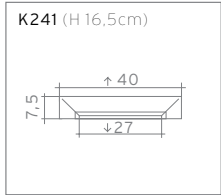

<p>K1122 (H 29,5cm)</p>	<p>K1112 (H 30cm)</p>	<p>K1142 (H 12,5cm)</p>	<p>K1122 (H 29,5cm)</p>	<p>K1112 (H 30cm)</p>	<p>K1142 (H 12,5cm)</p>	<p>K1122 (H 29,5cm)</p>	<p>K1112 (H 30cm)</p>
<p>K1122</p>	<p>K1112</p>	<p>K1142</p>	<p>K1122</p>	<p>K1112</p>	<p>K1142</p>	<p>K1122</p>	<p>K1112</p>
<p>K1002 (H 200cm)</p>	<p>K1002 (H 200cm)</p>	<p>K1002 (H 200cm)</p>	<p>K1102 (H 201cm)</p>	<p>K1102 (H 201cm)</p>	<p>K1002 (H 200cm)</p>	<p>K1002 (H 200cm)</p>	<p>K1002 (H 200cm)</p>
<p>K1152 (H 12cm)</p>	<p>K1152 (H 12cm)</p>	<p>K1152 (H 12cm)</p>	<p>K1152 (H 12cm)</p>	<p>K1152 (H 12cm)</p>	<p>K1152 (H 12cm)</p>	<p>K1132 (H 57cm)</p>	<p>K1132 (H 57cm)</p>

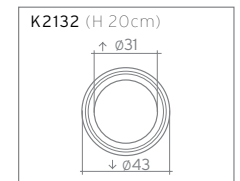
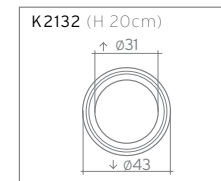
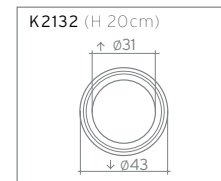
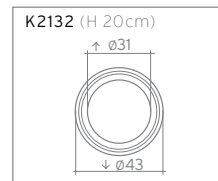
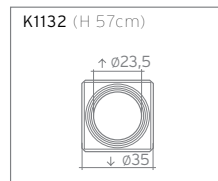
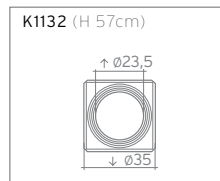
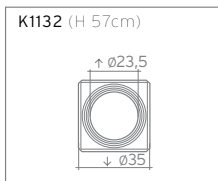
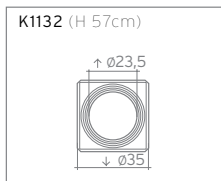
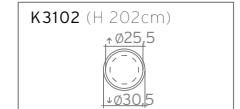
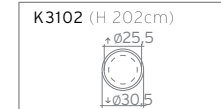
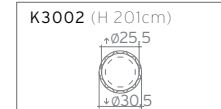
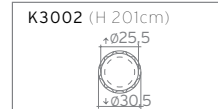
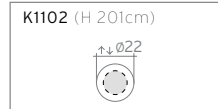
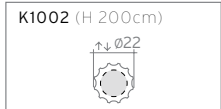
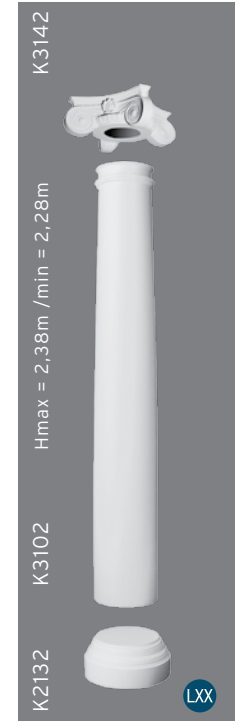
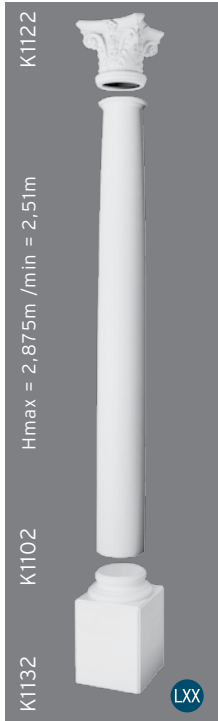
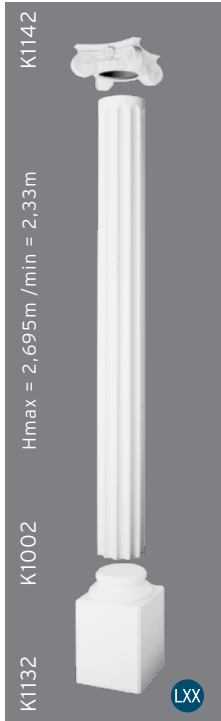
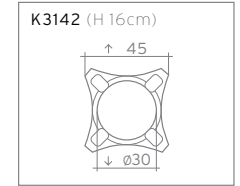
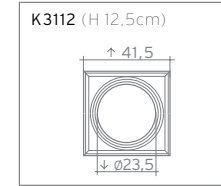
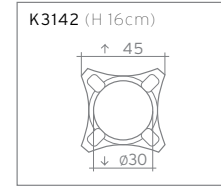
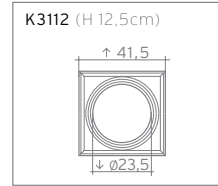
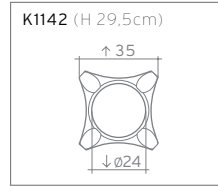
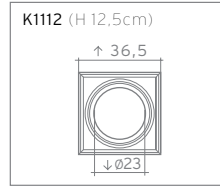
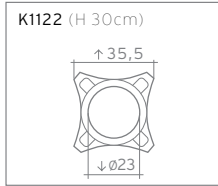
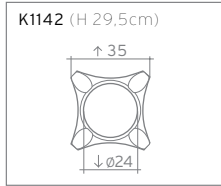

<p>K3112 (H 12,5cm)</p>	<p>K3142 (H 16cm)</p>	<p>K3112 (H 12,5cm)</p>	<p>K3142 (H 16cm)</p>	<p>K3112 (H 12,5cm)</p>	<p>K3142 (H 16cm)</p>	<p>K3112 (H 12,5cm)</p>	<p>K3142 (H 16cm)</p>
<p>K3112</p> <p>Hmax = 2,725m / min = 2,625m</p>	<p>K3142</p> <p>Hmax = 2,76m / min = 2,66m</p>	<p>K3112</p> <p>Hmax = 2,71m / min = 2,395m</p>	<p>K3142</p> <p>Hmax = 2,745m / min = 2,44m</p>	<p>K3112</p> <p>Hmax = 2,72m / min = 2,405m</p>	<p>K3142</p> <p>Hmax = 2,755m / min = 2,44m</p>	<p>K3112</p> <p>Hmax = 3,10m / min = 2,785m</p>	<p>K3142</p> <p>Hmax = 3,135m / min = 2,82m</p>
<p>K3202</p>	<p>K3202</p>	<p>K3002</p>	<p>K3002</p>	<p>K3102</p>	<p>K3102</p>	<p>K3202</p>	<p>K3202</p>
<p>K2132</p> <p>LXX</p>	<p>K2132</p> <p>LXX</p>	<p>K3152</p> <p>LXX</p>	<p>K3152</p> <p>LXX</p>	<p>K3152</p> <p>LXX</p>	<p>K3152</p> <p>LXX</p>	<p>K3152</p> <p>LXX</p>	<p>K3152</p> <p>LXX</p>
<p>K3202 (H 240cm)</p>	<p>K3202 (H 240cm)</p>	<p>K3002 (H 201cm)</p>	<p>K3002 (H 202cm)</p>	<p>K3102 (H 202cm)</p>	<p>K3102 (H 202cm)</p>	<p>K3202 (H 240cm)</p>	<p>K3202 (H 240cm)</p>
<p>K2132 (H 20cm)</p>	<p>K2132 (H 20cm)</p>	<p>K3152 (H 57,5cm)</p>	<p>K3152 (H 57,5cm)</p>	<p>K3152 (H 57,5cm)</p>	<p>K3152 (H 57,5cm)</p>	<p>K3152 (H 57,5cm)</p>	<p>K3152 (H 57,5cm)</p>

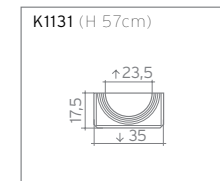
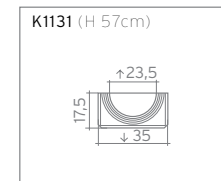
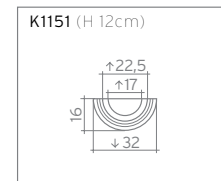
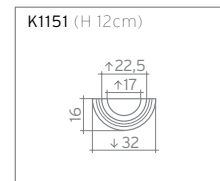
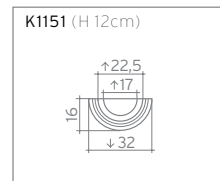
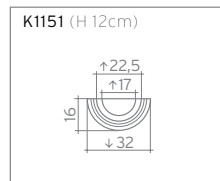
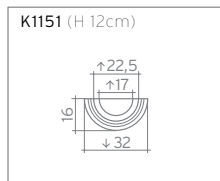
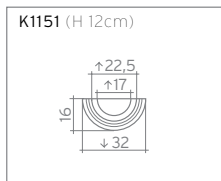
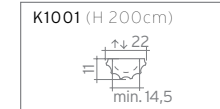
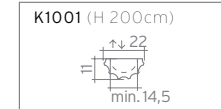
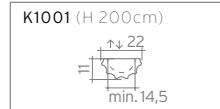
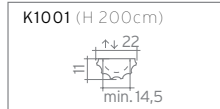
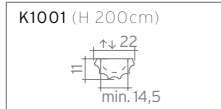
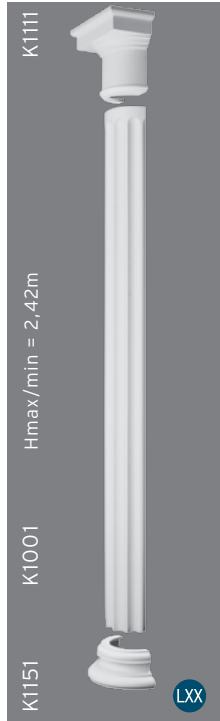
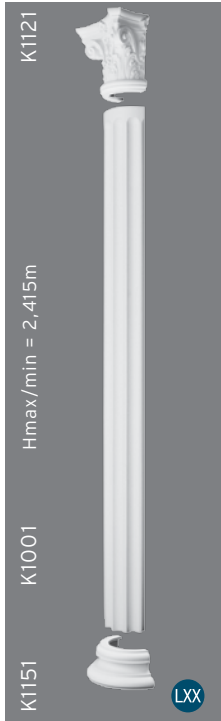
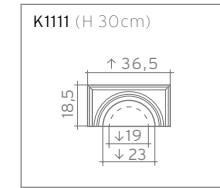
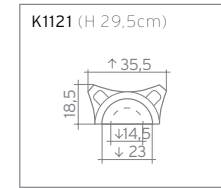
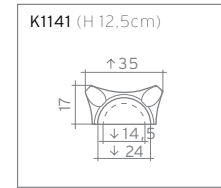
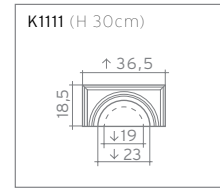
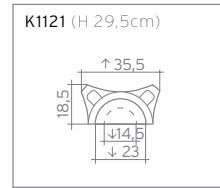
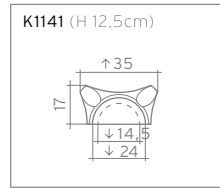
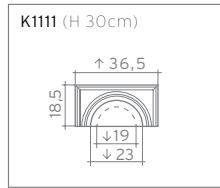
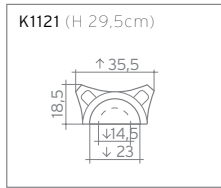



<p><b>K1141</b> (H 12,5cm)</p>	<p><b>K1121</b> (H 29,5cm)</p>	<p><b>K1111</b> (H 30cm)</p>	<p><b>K1141</b> (H 12,5cm)</p>	<p><b>K3111</b> (H 12,5cm)</p>	<p><b>K3141</b> (H 16cm)</p>	<p><b>K3111</b> (H 12,5cm)</p>	<p><b>K3141</b> (H 16cm)</p>
<p>K1141</p> <p>K1101</p> <p>K1131 <b>LXX</b></p>	<p>K1121</p> <p>K1101</p> <p>K1131 <b>LXX</b></p>	<p>K1111</p> <p>K1101</p> <p>K1131 <b>LXX</b></p>	<p>K1141</p> <p>K1101</p> <p>K1131 <b>LXX</b></p>	<p>K3111</p> <p>K3001</p> <p>K2131 <b>LXX</b></p>	<p>K3141</p> <p>K3001</p> <p>K2131 <b>LXX</b></p>	<p>K3111</p> <p>K3001</p> <p>K2131 <b>LXX</b></p>	<p>K3141</p> <p>K3001</p> <p>K2131 <b>LXX</b></p>
<p><b>K1001</b> (H 200cm)</p>	<p><b>K1101</b> (H 201cm)</p>	<p><b>K1101</b> (H 201cm)</p>	<p><b>K1101</b> (H 201cm)</p>	<p><b>K3001</b> (H 201cm)</p>	<p><b>K3001</b> (H 201cm)</p>	<p><b>K3101</b> (H 202cm)</p>	<p><b>K3101</b> (H 202cm)</p>
<p><b>K1131</b> (H 57cm)</p>	<p><b>K1131</b> (H 57cm)</p>	<p><b>K1131</b> (H 57cm)</p>	<p><b>K1131</b> (H 57cm)</p>	<p><b>K2131</b> (H 20cm)</p>	<p><b>K2131</b> (H 20cm)</p>	<p><b>K2131</b> (H 20cm)</p>	<p><b>K2131</b> (H 20cm)</p>

<p><b>K3111</b> (H 12,5cm)</p>	<p><b>K3141</b> (H 16cm)</p>	<p><b>K3111</b> (H 12,5cm)</p>	<p><b>K3141</b> (H 16cm)</p>	<p><b>K3111</b> (H 12,5cm)</p>	<p><b>K3141</b> (H 16cm)</p>	<p><b>K3111</b> (H 12,5cm)</p>	<p><b>K3141</b> (H 16cm)</p>
<p><b>K3111</b></p>	<p><b>K3141</b></p>	<p><b>K3111</b></p>	<p><b>K3141</b></p>	<p><b>K3111</b></p>	<p><b>K3141</b></p>	<p><b>K3111</b></p>	<p><b>K3141</b></p>
<p><b>K3201</b> (H 240cm)</p>	<p><b>K3201</b> (H 240cm)</p>	<p><b>K3001</b> (H 201cm)</p>	<p><b>K3001</b> (H 202cm)</p>	<p><b>K3101</b> (H 202cm)</p>	<p><b>K3101</b> (H 202cm)</p>	<p><b>K3201</b> (H 240cm)</p>	<p><b>K3201</b> (H 240cm)</p>
<p><b>K2131</b> (H 20cm)</p>	<p><b>K2131</b> (H 20cm)</p>	<p><b>K3151</b> (H 57,5cm)</p>	<p><b>K3151</b> (H 57,5cm)</p>	<p><b>K3151</b> (H 57,5cm)</p>	<p><b>K3151</b> (H 57,5cm)</p>	<p><b>K3151</b> (H 57,5cm)</p>	<p><b>K3151</b> (H 57,5cm)</p>



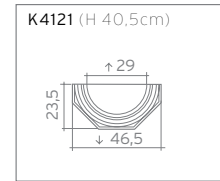
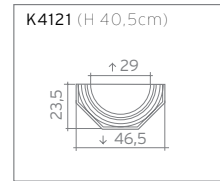
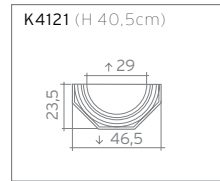
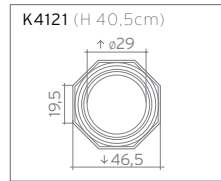
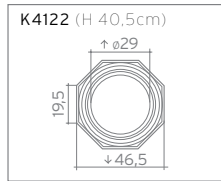
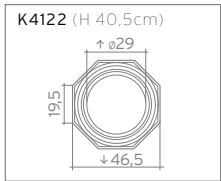
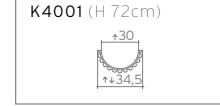
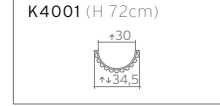
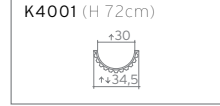
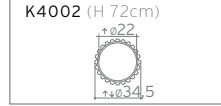
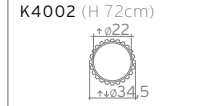
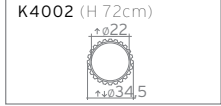
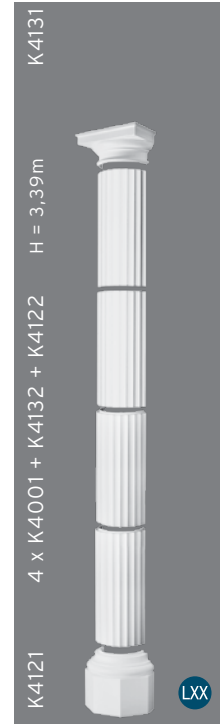
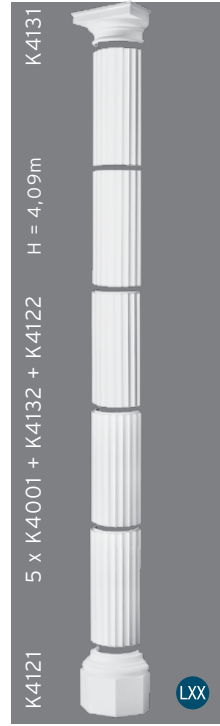
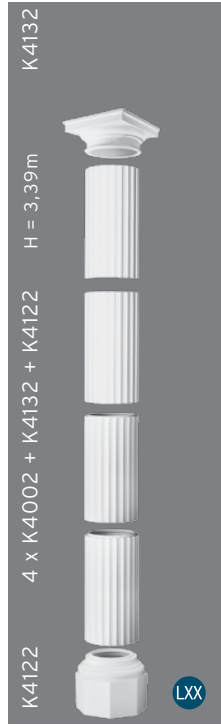
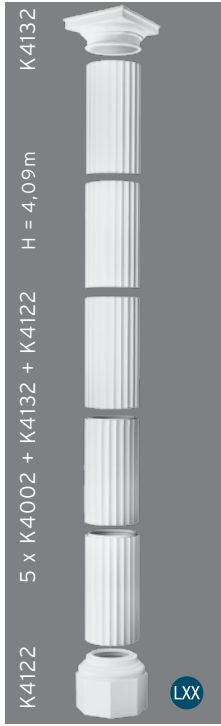
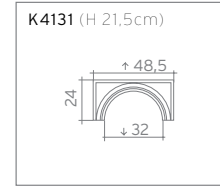
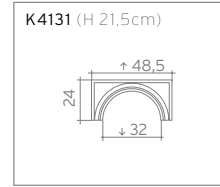
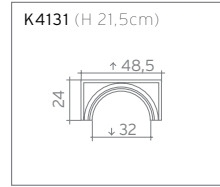
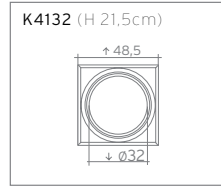
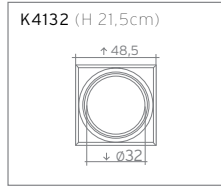
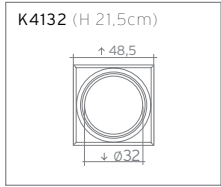



## PO

Elementy oświetleniowe Orac zostały opracowane zgodnie z najwyższymi standardami i dopasowane do profili Orac ażeby stworzyć optymalny efekt świetlny i zagwarantować pełne bezpieczeństwo. Podczas korzystania z oświetlenia innych producentów należy przestrzegać wszystkich zaleceń żeby zapewnić bezpieczeństwo.

## RU

Элементы освещения Orac были разработаны в соответствии с высочайшими стандартами, чтобы создать оптимальный эффект света. Все элементы абсолютно безопасны и соответствуют профилям Orac. При использовании систем освещения, не принадлежащим ORAC, пожалуйста, соблюдайте все инструкции для безопасности.

## AR

إن أنظمة إضاءة أورك مصممة وفقاً لأعلى المعايير لتتناسب مع قوالب أورك، مما يضمن إنارة مثالية وسلامة كاملة. عند استخدام أنظمة إضاءة غير أنظمة أورك مع قوالب أورك، يرجى أخذ بعين الإعتبار كافة التوجيهات حرصاً على السلامة.

## FR

Développés selon les normes les plus strictes, les éléments d'éclairage Orac ont été conçus spécialement pour les moulures Orac afin de garantir un effet lumineux optimal et une sécurité totale. Si vous utilisez des systèmes d'éclairage non Orac, veuillez tenir compte des prescriptions en vue de garantir la sécurité.

## ENG

The Orac lighting elements have been developed in accordance with the highest standards to fit the Orac profiles to create an optimal light effect and guarantee complete safety. When using non-Orac lighting systems, please observe all of the directives to ensure that safety is guaranteed.

## IL000-001

5 x pleksi pokrywa C357, L 100cm  
5 x верхний рассеиватель из плексиглаза  
для C357, длина 100cm  
5 x أغطية من زجاج البلكسي لكرانيش  
C357، طول 100 سم

5 x couvertures en plexi pour C357, L 100cm  
5 x plexi cover for C357, L 100cm

## IL000-002

5 x pleksi pokrywa C358, L 100cm  
5 x верхний рассеиватель из плексиглаза  
для C358, длина 100cm  
5 x أغطية من زجاج البلكسي لكرانيش  
C358، طول 100 سم

5 x couvertures en plexi pour C358, L 100cm  
5 x plexi cover for C358, L 100cm



## C900

PUROTOUCH®  
200 x17 x 14,5 cm



∇ = 22,6

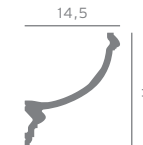

## C901

PUROTOUCH®  
200 x15 x 12,5 cm



∇ = 19,5

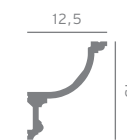

## C902

PUROTOUCH®  
200 x10 x 10 cm



∇ = 14,1

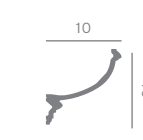

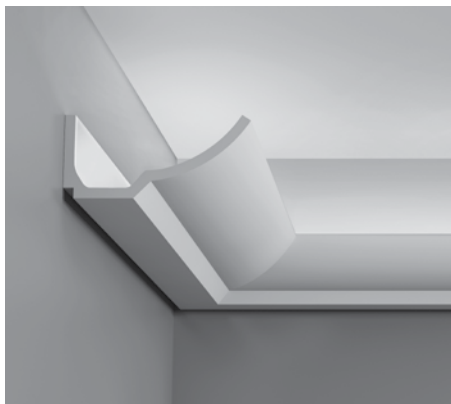

C351 - Designed by Jacques Vergracht

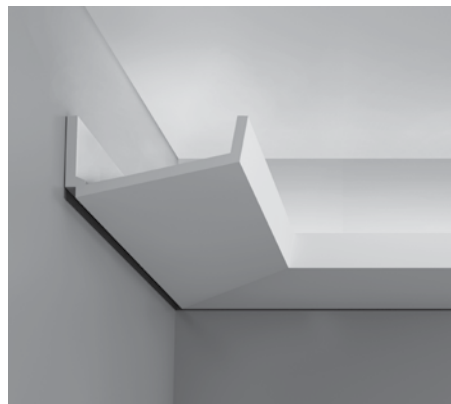
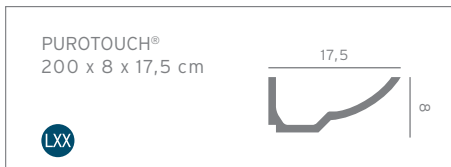

C352 - Designed by Jacques Vergracht

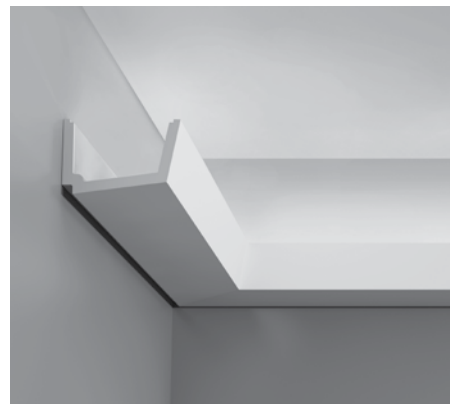
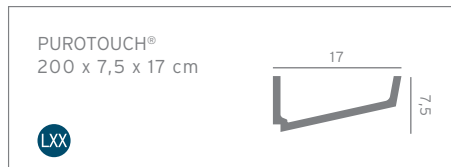

C357 - Designed by Jacques Vergracht

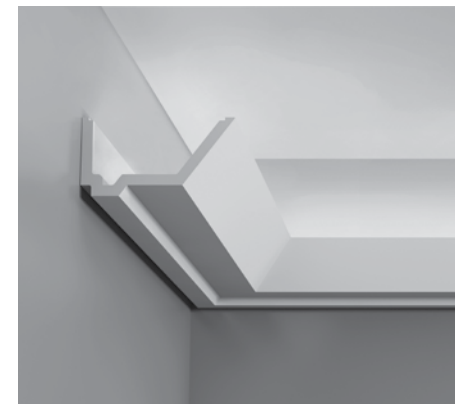
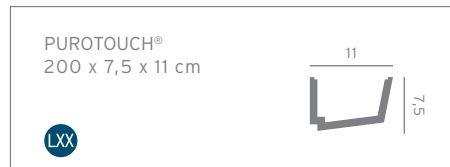

C358 - Designed by Jacques Vergracht

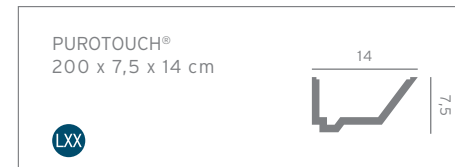

C361 - Designed by Pierre Daems

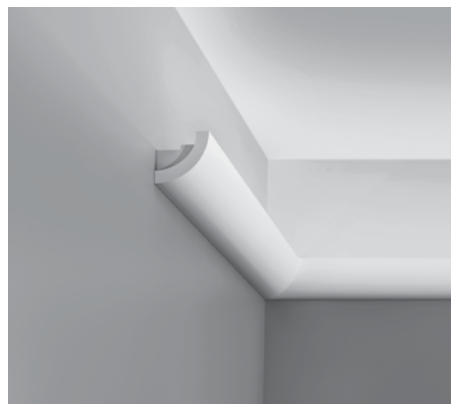
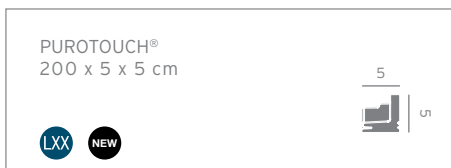

C362 - Designed by Pierre Daems

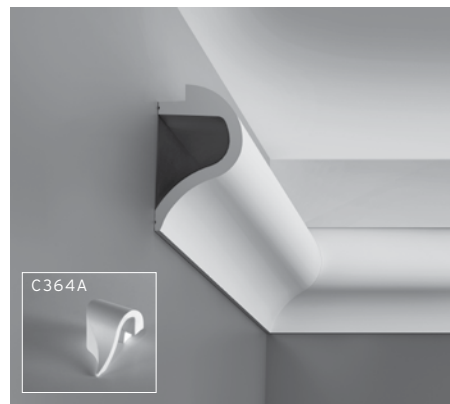
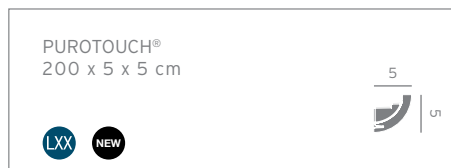

C364 - Designed by Pierre Daems

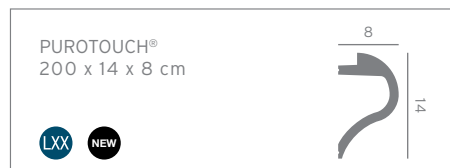

C363 - Designed by Pierre Daems

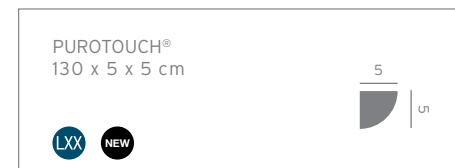



## led bars

26 cm 

114,5 cm 

IP CLASS	LOW LUMEN LED BAR	HIGH LUMEN LED BAR
VOLTAGE	24 V	24 V
COLOUR TEMPERATURE	WARM WHITE 2700 - 2900K	WARM WHITE 2700 - 2900K
LIGHT OUTPUT / METER	+/- 100 Lm/M	+/- 500 Lm/M
CRI	80	80
LIFE SPAN (AVGE LUMEN MAINTENANCE)	30 000 HOURS	30 000 HOURS
POWER	+/- 4 W/M	+/- 10,5 W/M

-  MAXIMUM LENGTH OF LED BARS CONNECTED TO A DRIVER (60 W)
-  MAXIMUM CABLE LENGTH FROM DRIVER TO LED BAR CONNECTOR

12 M

6 M

5 M

5 M

## led connecting cable / led driver



IL004-003 Waterproof convertor for IL004 (60W) - 15x6,8x5 cm

IP CLASS	IP67
POWER	60 W
INPUT VOLTAGE	240 VAC, MAX. 300 MA
OUTPUT	24 VDC, MAX. 2500 MA



IL004-001 + IL004-002

IL004-001 - 26x2x1,5 cm  
IL004-002 - 114,5x2x1,5 cm

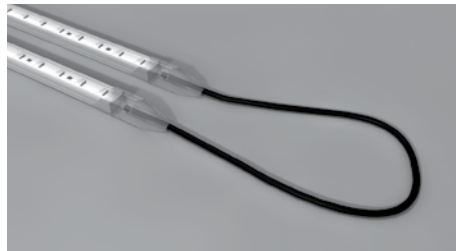

IL004-004

IL004-004 - 12,5 cm



IL004-003 + IL004-005

IL004-005 - 100 cm

## T5 tube



	T5 TUBE 1X14W	T5 TUBE 1X28W
IP CLASS	IP20	IP20
VOLTAGE	230 V	230 V
COLOUR TEMPERATURE	WARM WHITE 2700K	WARM WHITE 2700K
LIGHT OUTPUT / METER	1350 Lm/M	2900 Lm/M
POWER	14 W	28 W
LIFE SPAN	15 000 HOURS	15 000 HOURS
⚠️ MAXIMUM QUANTITY OF T5 FIXTURES TO BE CONNECTED	12	12

## T5 tube power feed



### T5 TUBE 1X14W

IL002-001  
T5 tube fixture incl. T5 tube HE 59 cm

### T5 TUBE 1X28W

IL002-002  
T5 tube fixture incl. T5 tube HE 119 cm

### IL002-003 L 180CM



### T5 tube (14W + 28W) + IL002-003

T5 tube 14W - 59 cm

T5 tube 28W - 119 cm

IL002-003 - 180 cm





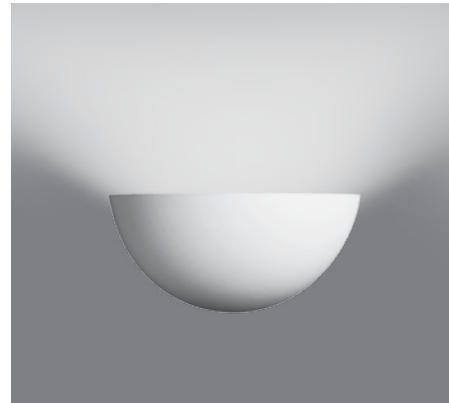
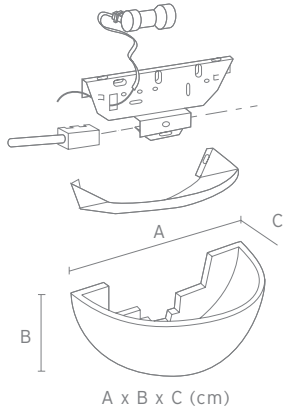

L504

DUROPOLYMER®  
30,5 x 15 x 15 cm

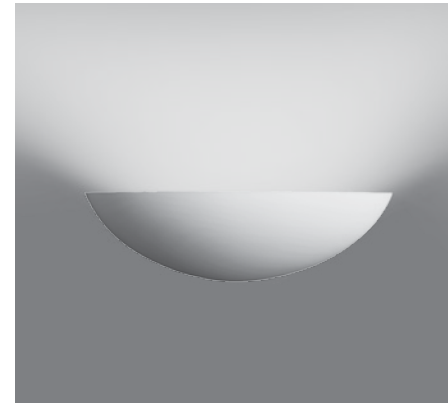

L505

DUROPOLYMER®  
41 x 11,5 x 16,5 cm

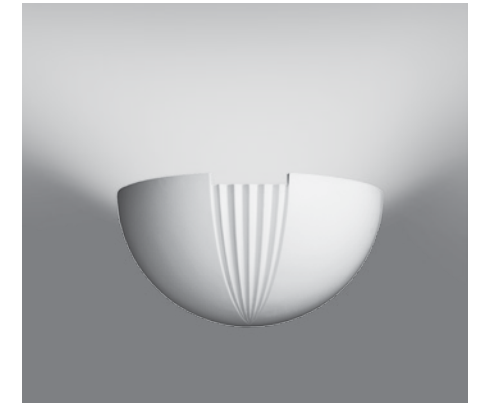

L509

DUROPOLYMER®  
29 x 17 x 14,5 cm

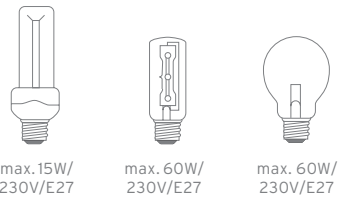

L512

DUROPOLYMER®  
30,5 x 12,5 x 15,5 cm



L506

DUROPOLYMER®  
39 x 15,5 x 19 cm



L501

DUROPOLYMER®  
35 x 22 x 16 cm



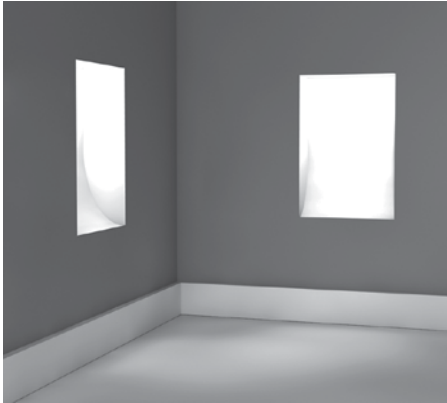

L600-001 XINNIX

19,5 x 8,5 x 34 cm

220V  
240V  
50Hz

10.000 hrs

LOW ENERGY

MicroLynx

IP20

34

8,5

Oprawy do montażu lamp energooszczędnych (18W - G24 - q2)  
Встраиваемый светильник для энергосберегающей лампы (18 Вт - G24 - q2)  
luminaire encastrée pour lampe économique (18W - G24 - q2)  
Recessed fixture for energy saving lamp (18W - G24 - q2)  
مصباح ضمن الجدار للمبات موفرة للطاقة (18W - G24 - q2)

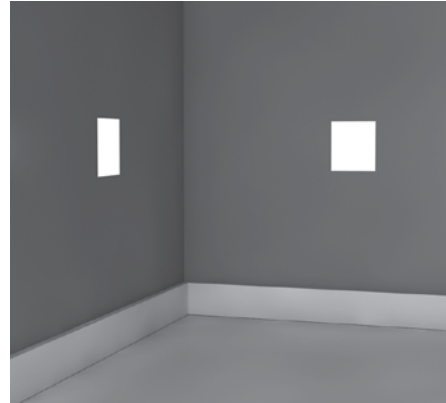

L601-001 XINNIX

10 x 9 x 10 cm

220V  
240V  
50Hz

10.000 hrs

LOW ENERGY

MicroLynx

IP20

10

9

Oprawy urządzenia MycroLynx F7W (biały & kolor) lub MycroLynx LED (biały & kolor)  
Встраиваемый светильник для MycroLynx F7W (белый и цветной) или MycroLynx LED (белый и цветной)  
Luminaire encastré pour MycroLynx F7W (en blanc et en couleur) ou MycroLynx LED (en blanc et en couleur)  
Recessed fixture for MycroLynx F7W (white & color) or MycroLynx LED (white & color)  
F7W مصباح ضمن الجدار للمبات مايكرولينكس (أبيض وملون) أو مايكرولينكس LED (أبيض وملون)



ILO03-011 LED INSERT

4 x 0,9 x 4,6 cm

12V

IP20

LOW ENERGY

10.000 hrs

3200K

4

0,9

4,6

Zestaw 5 diod LED (1 dioda LED = 0,2 W)  
+ 5 kabli przedłużających (5x1m).  
Istnieje możliwość wymiany pojedynczej diody LED.  
Набор из 5 СВЕТОДИОДНЫХ ВКЛАДЫШЕЙ (1 LED = 0,2W) + 5 монтажных кабелей (5x1m) Возможность замены отдельной светодиодной лампы  
Set de 5 LEDS (1 LED = 0,2W)  
+ câbles d'extension (5x1m) Possibilité de changer une lampe LED  
Set of 5 LEDS (1 LED = 0,2W)  
+ 5 extension cables (5x1m)  
Possible to replace a single LED lamp  
مجموعة من 5 لمبات LED (كل لمبة = 0,2 واط) + كابلات تمديد (5 x 1 م) من الممكن إستبدال لمبة واحدة

ILO03-012 TRANSFO

6 x 3,5 x 2 cm

12V

IP20

F

6

3,5

2

Teransformator max. 20 lamp  
Преобразователь напряжения максимум на 20 лампочек  
Converteur de puissance max. 20 lamps  
Convector max. 20 lamps  
محول ٢٠ لمبة كحد أقصى

PO

## Kleje



Klejenie na ścianie i suficie



Połączenia



Do Basixx użyj DecoFix Pro do połączeń



Klejenie na ścianie i suficie



Połączenia



Do Basixx użyj DecoFix Pro do połączeń

TYLKO PEŁNA GWARANCJA Z DECOFIX

	DecoFix Pro FDP500 310ml > 7 do 8m FDP600 4200ml > 65 do 110m	<ul style="list-style-type: none"> <li>Mocny, akrylowy klej na bazie wody</li> <li>Trwałe połączenie między profilem a ścianą i/lub sufitem</li> <li>Do zastosowań wewnętrznych i powierzchni porowatych (nie do wilgotnych pomieszczeń i na zewnątrz)</li> <li>Usuń wilgotną gąbką lub szmatką</li> <li>Chronić przed mrozem</li> </ul>
	DecoFix Extra FX200 310ml > min. 80m FX210 80ml > min. 20m	<ul style="list-style-type: none"> <li>Klej na bazie poliuretanu</li> <li>Na łączenia między profilami</li> <li>Usunąć nadmiar kleju przed utwardzeniem (max. 1 godziny i powtórzyć po 2-3 godzinach)</li> <li>Czyścić acetonem lub syntetycznym rozcieńczalnikiem</li> <li>Można malować po 24 godzinach</li> <li>Im mniejsza wilgotność powietrza tym szybszy czas schnięcia</li> </ul>
	DecoFix Hydro FDP700 290 ml > 7 do 8 m	<ul style="list-style-type: none"> <li>Bardzo mocny klej MS polimerowy</li> <li>Do zastosowań zewnętrznych, wilgotnych warunkach</li> <li>Gładkie powierzchnie ( płytki, szkło, ...)</li> <li>Usuwać roztworem z mydła</li> </ul>

RU

## Клеи

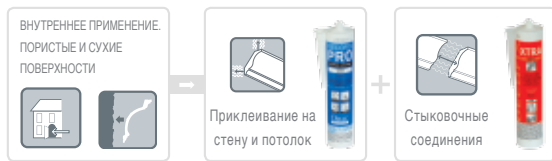

Приклеивание на стену и потолок

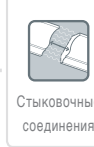

Стыковочные соединения



Используйте DecoFix Pro для соединения швов коллекции Basixx

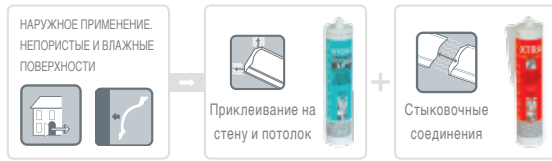

Приклеивание на стену и потолок

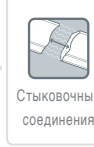

Стыковочные соединения



Используйте DecoFix Pro для соединения швов коллекции Basixx

ГАРАНТИЯ ДЕЙСТВУЕТ ТОЛЬКО ПРИ ИСПОЛЬЗОВАНИИ КЛЕЯ DECOFIX

	DecoFix Pro FDP500 310ML > 7 - 8м.п. FDP600 4200мл > 65 - 110м.п.	<ul style="list-style-type: none"> <li>Стойкий, акриловый клей на водной основе</li> <li>Долговечное соединение между молдингами и стеной и/или потолком</li> <li>Для внутренних работ и пористых поверхностей (не для влажных помещений и не для наружного применения)</li> <li>Удаляется с помощью влажной губки или тряпки</li> <li>Хранить не замораживая</li> </ul>
	DecoFix Extra FX200 310ML > МИН. 80М.П. FX210 80ML > МИН. 20М.П.	<ul style="list-style-type: none"> <li>Стыковочный клей на полиуретановой основе для соединительных швов лепного декора</li> <li>Избыток клея предпочтительно удалить после затвердевания (по прошествии не меньше 24 часов)</li> <li>Излишки и пятна клея следует удалять немедленно с помощью ацетона или растворителя</li> <li>Лепной декор можно окрашивать через 24 часа</li> <li>Чем больше влажность, тем меньше время высыхания</li> </ul>
	DecoFix Hydro FDP700 290ML > 7 - 8 м.п.	<ul style="list-style-type: none"> <li>Монтажный полимерный клей и наполнитель</li> <li>Используйте DecoFix Hydro для наружного применения, в помещениях с повышенной влажностью, непористых поверхностях (плитка, стекло, ...) вместо DecoFix Pro</li> <li>Излишки клея удаляются мыльным раствором до застывания</li> </ul>

AR

## المواد اللاصقة



لصق على جدار وسقف



فواصل



مع أصناف بيزكس يستعمل ديكوفيكس برو للفواصل



لصق على جدار وسقف



فواصل



مع أصناف بيزكس يستعمل ديكوفيكس برو للفواصل

ضمانة كاملة فقط مع ديكوفيكس

	ديكوفيكس برو FDP500 310 مل < 8 أ.م FDP600 4200 مل > 65 إلى 110 م	<ul style="list-style-type: none"> <li>غراء أكريليك قوي، أساسه ماء</li> <li>لصق متين بين القوالب والجدار وأو السقف</li> <li>للإستعمال في الداخل وعلى أسطح مسامية (لا يصلح للخارج أو في أماكن رطبة)</li> <li>يزال بإستجابة أو قماش رطب</li> <li>يحفظ محميا من الجليد</li> </ul>
	ديكوفيكس إكسترا FX200 310 مل < 80 م على الأقل FX210 80 مل < 20 م على الأقل	<ul style="list-style-type: none"> <li>غراء بوليوريثين</li> <li>للصق الفواصل بين القوالب</li> <li>يزال فائض الغراء قبل أن يصلب (بعد ساعة كحد أقصى، ومجددا بعد 2-3 ساعات)</li> <li>ينظف بأستون أو مرقق إصطناعي</li> <li>يمكن طلاؤه بعد 24 ساعة</li> <li>ينشف بسرعة أكبر مع ارتفاع درجة الرطوبة</li> </ul>
	ديكوفيكس هايبرو FDP700 290 مل < 7 إلى 8 أ.م	<ul style="list-style-type: none"> <li>غراء م.س. بوليمر قوي جدا</li> <li>للإستعمال في الخارج، في أماكن رطبة، وعلى أسطح غير مسامية (بلاط، زجاج...)</li> <li>يزال بالماء والصابون</li> </ul>

FR  
Colles

SURFACES POREUSES, PIÈCES NON HUMIDES

Collage sur mur et plafond

Joints

Pour Basixx utilisez DecoFix Pro pour les joints

ENVIRONNEMENT HUMIDE, SURFACES NON POREUSES, POSE À L'EXTÉRIEUR

Collage sur mur et plafond

Joints

Pour Basixx utilisez DecoFix Pro pour les joints

GARANTIE TOTALE UNIQUEMENT AVEC COLLE DECOFIX

	DecoFix Pro FDP500 310ml > 7 à 8m FDP600 4200ml > 65 à 110m	<ul style="list-style-type: none"> <li>Colle forte à base d'eau et d'acrylique</li> <li>Joint longue durée entre les moulures et le mur et/ou le plafond</li> <li>Pour les applications intérieures et les surfaces poreuses (hors environnement humide ou extérieur)</li> <li>Retirez à l'aide d'une éponge ou d'un chiffon humide</li> <li>Doit être conservée à l'abri du gel</li> </ul>
	DecoFix Extra FX200 310ml > min. 80m FX210 80ml > min. 20m	<ul style="list-style-type: none"> <li>Colle polyuréthane</li> <li>Pour l'assemblage des joints entre les moulures</li> <li>Éliminez les excès de colle avant le durcissement (1 heure max. et recommencez après 2-3 heures)</li> <li>Nettoyez avec de l'acétone ou un diluant synthétique</li> <li>Peut être peint après 24 h</li> <li>Humidité est importante</li> </ul>
	DecoFix Hydro FDP700 290 ml > 7 à 8 m	<ul style="list-style-type: none"> <li>Colle au MS polymère extra forte</li> <li>Pour les applications extérieures, les environnements humides, les surfaces non poreuses (carrelage, verre, etc.)</li> <li>Enlevez à l'aide d'une solution savonneuse</li> </ul>

EN  
Glues

INTERIOR, POROUS AND DRY SURFACE

Gluing on wall and ceiling

Joints

For Basixx use DecoFix Pro for joints

EXTERIOR, NON-POROUS AND HUMID SURFACE

Gluing on wall and ceiling

Joints

For Basixx use DecoFix Pro for joints

ONLY FULL GUARANTEE WITH DECOFIX

	DecoFix Pro FDP500 310ml > 7 to 8m FDP600 4200ml > 65 to 110m	<ul style="list-style-type: none"> <li>Strong, water-based acrylic glue</li> <li>Long-lasting seal between mouldings and the wall and/or ceiling</li> <li>For interior applications and porous surfaces (not for humid spaces or outside)</li> <li>Remove with humid sponge or cloth</li> <li>Should be kept frost free</li> </ul>
	DecoFix Extra FX200 310ml > min. 80m FX210 80ml > min. 20m	<ul style="list-style-type: none"> <li>Polyurethane-based glue</li> <li>Seam joints between the mouldings</li> <li>Remove excess glue before hardening (max. 1 hour and repeat after 2-3 hours)</li> <li>Clean with acetone or Synth Thinner</li> <li>Can be painted after 24 hrs</li> <li>The more humidity, the faster the drying time</li> </ul>
	DecoFix Hydro FDP700 290 ml > 7 to 8 m	<ul style="list-style-type: none"> <li>Extra strong MS polymer glue</li> <li>For exterior applications, damp environments, non-porous surfaces (tiles, glass, ...)</li> <li>Remove with soap solution</li> </ul>



FB10  
A: max. 27,5 cm  
B: max. 22 cm

FB300  
A: max. 29,7 cm  
B: max. 29,1 cm

FB13  
A: max. 12,5 cm  
B: max. 15,5 cm

FB14

FDP100

FX210 FX200

FDP600

FDP500

FDP700

FB15

Narożnik Wewnętrzny | Внутренний Угол | زاوية داخلية | Coin Intérieur | Inside Corner

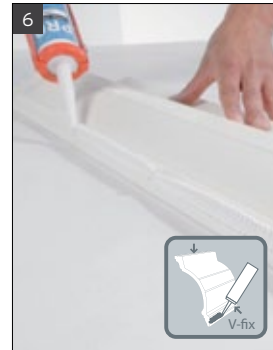
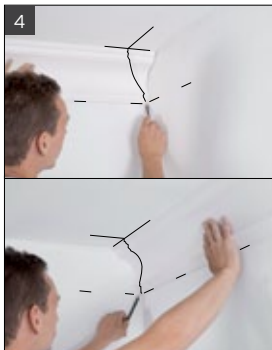
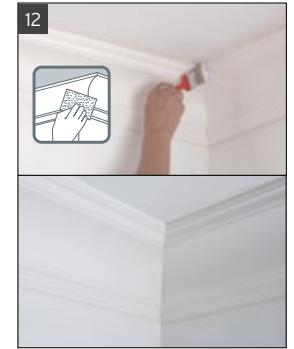

Narożnik zewnętrzny |  
Наружный угол |  
زاوية خارجية | Coin Extérieur |  
Outside Corner

Ukośnica | قص مشطوب |  
Couper en Onglets |  
Stop Mitre

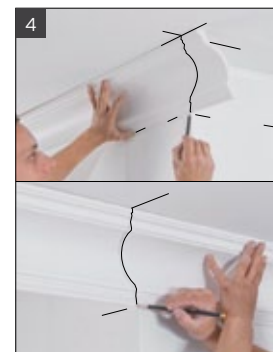

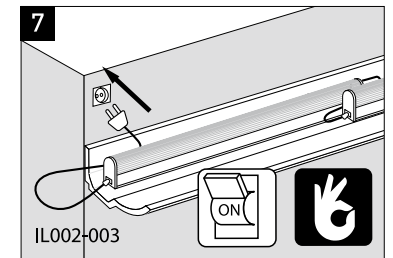
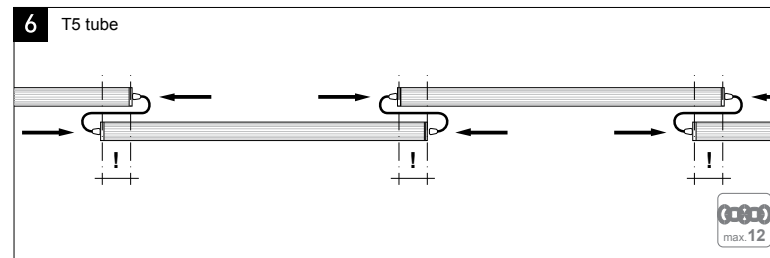
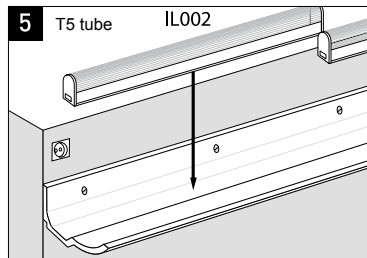
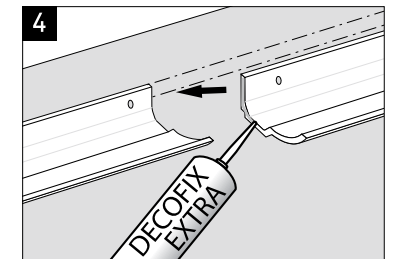
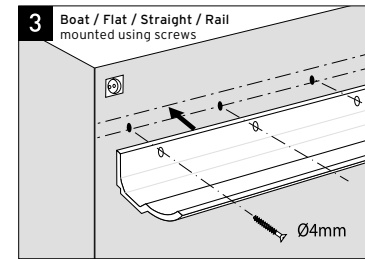
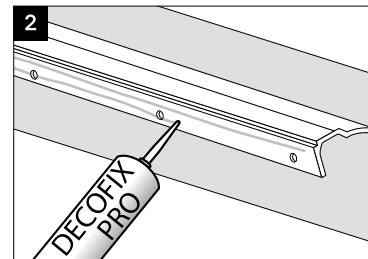
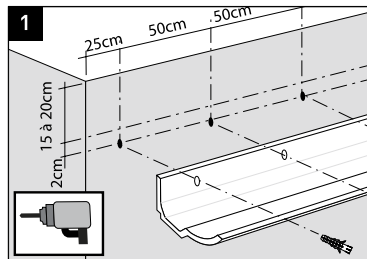
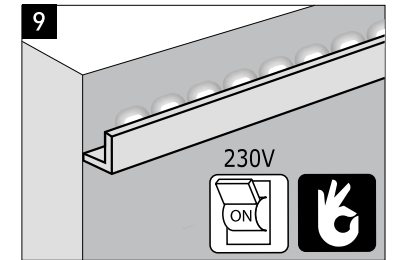
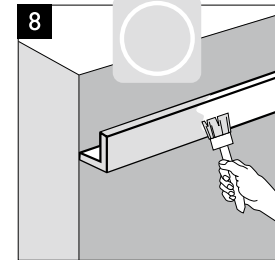
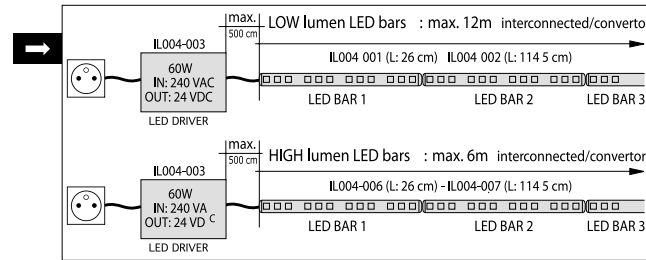
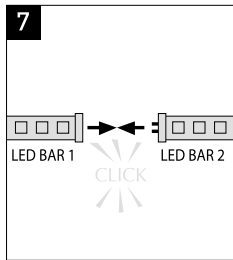
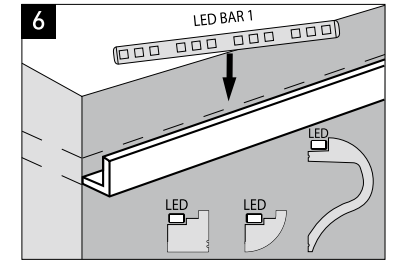
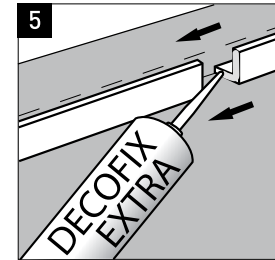
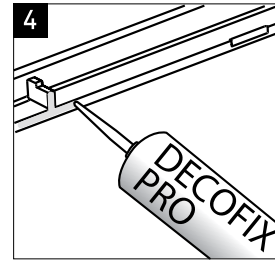
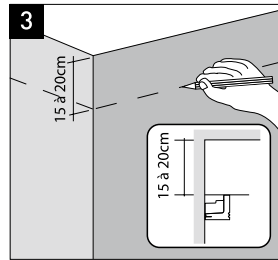
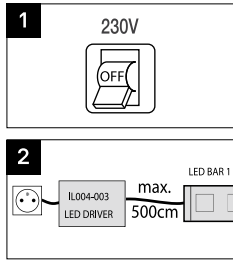



ORAC DECOR XXL 1 CASE  
MS046-001 XX AXX BXX



ORAC DECOR XXL 2 CASE  
MS046-002 LXX AXX



ORAC DECOR XXL 3 CASE  
MS046-003 LXX



ORAC DECOR MEDIUM 1 CASE  
A45-001 AXX BXX



ORAC DECOR MEDIUM 2 CASE  
A45-002 AXX LXX



ORAC DECOR  
DISPLAY LUXUS Collection MD016-001

ALSO AVAILABLE:  
DISPLAY AXXENT Collection MD016-002  
DISPLAY BASIXX Collection MD017-002



ORAC DECOR SKIRTING BOX  
MS008-001



ORAC DECOR ARCHIBOX  
MS010-002



ORAC DECOR WALL + SAMPLE SLIDE SYSTEM  
MD013-405

'Also available without sample slide system' MD013-005



ORAC DECOR CORNER - WITHOUT SAMPLE SLIDE SYSTEM  
MD013-006

'Also available with sample slides system' MD013-406



ORAC DECOR TOWER MEDIUM  
MD013-019



PO

**ZEWNĘTRZNA APLIKACJA**

Wszystkie produkty Orac Luxxus jak również Orac Axxent mogą być używane do zastosowań zewnętrznych i w wilgotnych pomieszczeniach. Kleimy profile w ten sam sposób jak wewnątrz ale zastępujemy klej DecoFix Pro klejem DecoFix Hydro. Produkty muszą być pokryte farbą zewnętrzną.

**INSTALACJA WEWNĘTRZNYCH PROFILI**

Warunki gwarancji są ważne jedynie jeśli używa się profili zgodnie z przeznaczeniem i instrukcją montażu.

**GWARANCJA**

ORAC DECOR® profile są nietłukące, lekkie i łatwe w montażu. Pokryte są warstwą podkładową. Wszystkie techniczne informacje znajdziesz na naszej stronie internetowej [www.oracdecor.com](http://www.oracdecor.com). Warunki gwarancji mają zastosowanie tylko w przypadku montażu zgodnego z instrukcją. Sprawdź wymiary profili zanim rozpoczniesz instalację, ponieważ mogą występować pewne różnice w wielkościach lub/i w kształtach od tych zawartych w katalogu. Nie wahaj się zadzwonić po wszystkie dodatkowe informacje, które mogą być potrzebne.

**STANDARDY OGNIOODPORNOŚĆ**

W wielu wnętrzach i projektach obowiązują surowe przepisy przeciwpożarowe. Dlatego, Orac wdrożył szereg rozwiązań w zależności od kraju i jego przepisów. Prosimy o kontakt z naszym działem inżynierii w celu uzyskania dodatkowych informacji.

RU

**НАРУЖНОЕ ПРИМЕНЕНИЕ**

Вся продукция Orac Luxxus и Orac Axxent может быть использована для наружного применения и в помещениях с повышенной влажностью. Используйте монтажный клей DecoFix Hydro для наружного применения и во влажных помещениях вместо DecoFix Pro. Все изделия должны быть покрыты специальным покрытием для наружных работ.

**МОНТАЖ КАРНИЗОВ**

Гарантия действует при условии соблюдения инструкций по работе

**ГАРАНТИЯ**

Изделия ORAC DECOR® легкие, ударопрочные, легко монтируются. Работать с ними нужно, как с легким деревом, покрывать высококачественной краской. Вся необходимую техническую информацию Вы можете найти на сайте компании [www.oracdecor.com](http://www.oracdecor.com). Гарантия действует при условии соблюдения инструкций по работе. Перед установкой проверьте, соответствуют ли размеры и орнамент изделия заказанным, возможны отклонения или изменения размеров от указанных в каталоге. Если нужна дополнительная информация, пожалуйста, звоните.

**СТАНДАРТ ОГНЕСТОЙКОСТИ**

На многие проекты и интерьеры распространяются строгие правила пожаробезопасности. В соответствии с чем, ORAC разработал ряд решений, в зависимости от страны и существующих там требований. Просьба, обращаться в наш проектный отдел за более подробной информацией.

AR

**إستعمال خارجي**

يمكن تركيب كافة أصناف أوراك لوكسس وأوراك أكسنت في الأماكن الخارجية والرطبة. يتم لصق هذه الأصناف كما في الأماكن الداخلية، ولكن مع إستعمال غراء ديكوفيكس هايدرو بدل ديكوفيكس برو. بعد التركيب، يتم طلاء القوالب بطلاء مناسب للإستعمال الخارجي.

**تركيب الكرائيش الصلبة في الداخل**

تنطبق شروط الكفالة فقط إذا اتبعت تعليمات التركيب بدقة تامة.

**كفالة**

أصناف أوراك ديكور متينة جدا، خفيفة وسهلة التركيب. تتم معالجتها مثل الخشب الخفيف، وهي مطلية بأساس للدهان ذات جودة عالية. كامل المعلومات التقنية موجودة على موقعنا [www.oracdecor.com](http://www.oracdecor.com). تنطبق شروط الكفالة فقط إذا اتبعت هذه التعليمات بدقة تامة. يجب التحقق من حجم القطع في الغرفة التي سيتم تركيبها فيها قبل البدء بعملية التركيب، إذ قد يكون هناك بعض التفاوت في الحجم و/أو الشكل مع ما هو مذكور في الكتالوج. لا تترددوا في الإتصال بنا لمزيد من المعلومات.

**معايير مقاومة الإحتراق**

للعديد من المنازل والمشاريع قوانين صارمة جدا في ما يتعلق بالوقاية من الحرائق. لذلك، تقدم أوراك بعض المنتجات والحلول التي تلبى معايير الحماية من الحرائق. يرجى الإتصال بنا لمزيد من المعلومات.

FR

---

**APPLICATIONS EXTÉRIEURES**

Tant les produits Orac Luxxus que les produits Orac Axxent conviennent pour l'extérieur et les endroits humides. Pour encoller ces produits, vous procédez de la même façon que pour les applications à l'intérieur, mais vous remplacez la DecoFix Pro par la DecoFix Hydro. Ces produits doivent être parachevés avec une peinture spéciale pour extérieur.

**INSTALLATION DE CORNICHES DURES DANS UN INTÉRIEUR**

Les conditions de garantie sont uniquement valables en cas d'observation complète des instructions de pose.

**GARANTIE**

Les ornements ORAC DECOR® sont incassables, légers et faciles à installer. Ils sont utilisés comme du bois léger et parachevés avec des peintures de qualité. Contrôlez les dimensions des ornements dans la pièce où ils doivent être installés, avant de procéder à l'installation, sous réserve de modifications et de discordances avec les mesures indiquées dans ce catalogue. N'hésitez pas à nous contacter pour obtenir de plus amples informations. Vous trouverez toutes les informations techniques sur [www.oracdecor.com](http://www.oracdecor.com). Les conditions de garantie ne sont d'application que si ces instructions ont été suivies à la lettre.

**NORMES ANTI-INCENDIE**

Pour beaucoup d'intérieurs et de projets, les exigences en terme de prévention incendie sont très strictes. C'est pour cette raison qu'Orac propose quelques produits répondant aux standards anti-feu et élabore des solutions adaptées aux exigences de votre projet. Contactez nous pour plus d'information.

EN

---

**EXTERIOR APPLICATIONS**

All Orac Luxxus as well as the Orac Axxent products can be used for exterior applications and in damp environments. To glue the ornaments, you proceed exactly as for interior applications, but you replace the DecoFix Pro adhesive product with DecoFix Hydro. The products have to be covered with a special coating for outside use.

**INTERIOR INSTALLATION OF RIGID CORNICE MOULDINGS**

Guarantee terms and conditions apply if provided installation instructions have been followed to the letter.

**GUARANTEE**

ORAC DECOR® ornaments are unbreakable, light and easy to install. They are processed in the same way as light wood and finished with a quality primer. You will find all the technical information on our website [www.oracdecor.com](http://www.oracdecor.com). Guarantee terms and conditions apply if provided instructions have been followed to the letter. Check the measurements of the ornaments on the premises before you start installing them, there may be some discrepancies in sizes or/and shapes against those stated in the catalogue. Do not hesitate to call for any further information you may require.

**FIRE RETARDANT STANDARDS**

On many interiors and projects strict fire regulations are imposed. Therefore, ORAC has implemented a number of solutions depending on the country and its regulations. Please contact our engineering department for more detailed requests.



DX162-2300



DX162-2300



DX162-2300

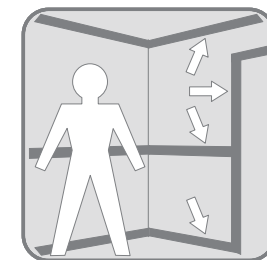
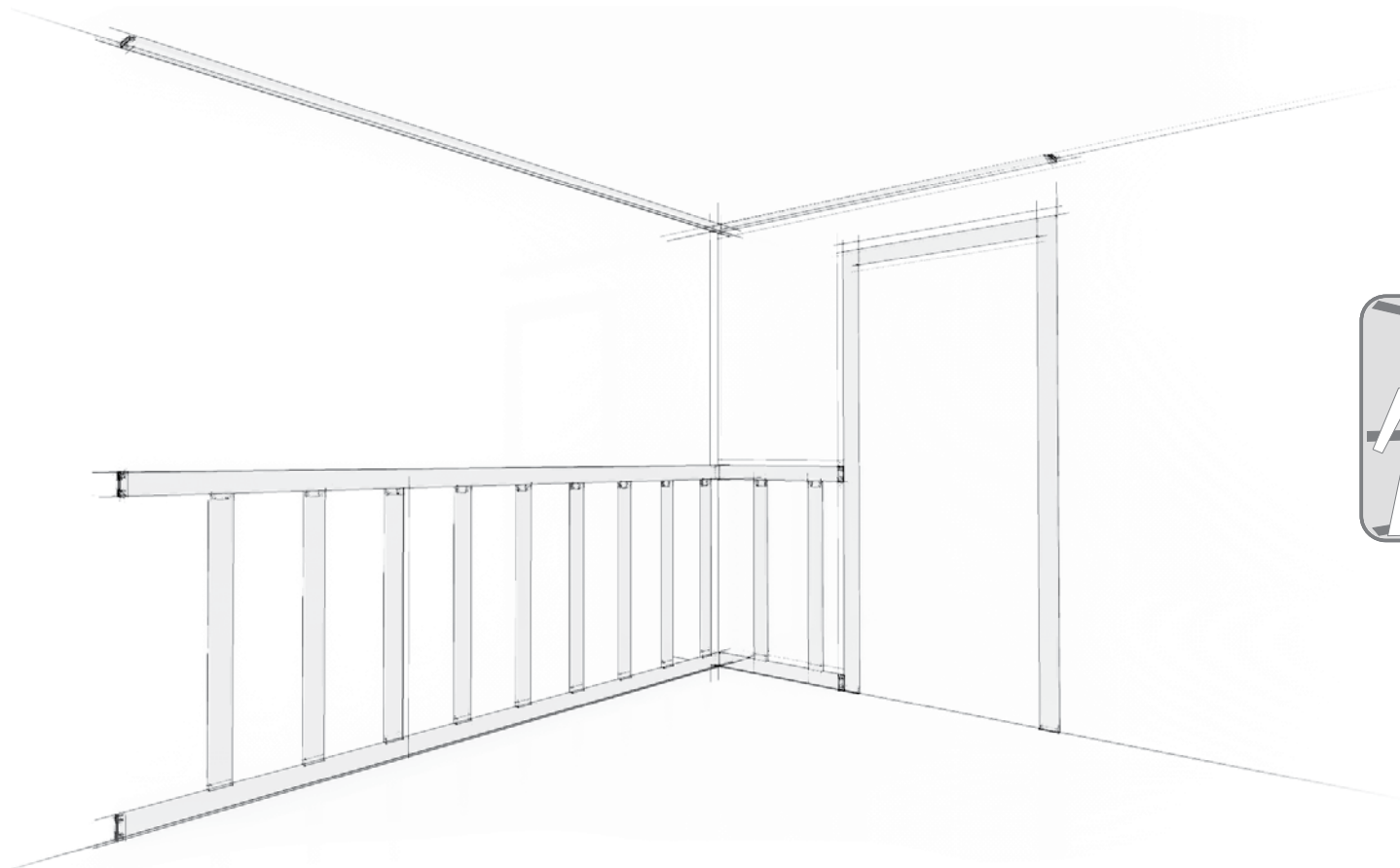

Nowe profile Axxent są multifunkjonalne i mogą być wykorzystywane do różnych zastosowań.

Новые профили Аххент многофункциональны и могут быть использованы для различных интерьерных задач.

أصناف أوزاك أكسنت الجديدة متعددة الإستعمالات.

Les nouveaux produits Axxent sont multifonctionnels et peuvent être utilisés pour plusieurs applications.

The new Axxent profiles are multifunctional and can be used for a variety of applications.

	Klasa I z uziemieniem - Класс безопасности I - سلامة درجة ١ مع تأريض - Classe I avec terre - Safety Class I with earthing		Dwielówka energooszczędna nie jest dołączona - Энергосберегающая лампа не прилагается - لا تتضمن لمبة موفرة للطاقة - Lampe économique non incluse - Energy saving lamp not included		Max. liczba połączonych ze sobą urządzeń - Макс. количество связующих элементов - الحد الأقصى لعدد المصابيح المترابطة - Max. nombre d'armatures en ligne - Max. number of fixtures interconnected
	Klasa II podwójna izolacja - Класс безопасности II - سلامة درجة ٢ عزل مزدوج - Classe II avec double isolation - Safety Class II double isolation		Lampa MicroLynx nie jest dołączona - MicroLynx лампочки не прилагаются - لا تتضمن لمبة مايكرولينكس - Lampe MicroLynx non incluse - MicroLynx lamp not included		Konkurencyjna cena - Доступен по бюджету - سعر اقتصادي - Prix économique - Budget friendly
	Klasa III niskie napięcie - Класс безопасности III - سلامة درجة ٣ توتر منخفض - Classe 3 basse tension - Safety Class III low voltage		Bez ściemniacza - Не диммер - قوة الضوء غير قابلة للتخفيف - Sans variateur - Not dimmable		Niskie zużycie energii - Низкое энергопотребление - Low energy use - Basse consommation d'énergie - إستهلاك منخفض للطاقة
	12V stałe napięcie - 12В постоянный ток - ١٢ فولت توتر مستمر - 12V tension continue - 12V constant tension		Ściemniacz - Диммер - قوة الضوء قابلة للتخفيف - Avec variateur - Dimmable		Łatwe w montażu - Легкость монтажа - سهولة التركيب - Installation très simple - Easy to install
	230V 240V 50Hz - 230 - 240 Volt - 230 - 240 V - ٥٠ هرتز - ٥٠ Hz - ٥٠ فولت		Elektroniczny ściemniacz - Электронный стабилизатор переключения света - صابورة إلكترونية مع إمكانية تخفيف - Ballast électronique avec variateur - Electronic dimmable ballast		Nadaje się do bezpośredniego montażu w / na powierzchniach łatworpalnych - Подходит для прямого крепления на легковоспламеняющиеся поверхности - مناسبة للتركيب مباشرة في/على أسطح قابلة للإشتعال - Convient pour un montage direct dans/sur des surfaces inflammables - Suitable for direct mounting in/on flammable surfaces
	Poziom ochrony - Уровень безопасности - مستوى الحماية - Indice de protection - Protection level		Temperatura barwowa lampy - Цветовая температура лампы - حرارة لون اللبنة - Température de couleur lampe - Colour temperature lamp		
	CE Standard - Качество CE - معيار الإتحاد الأوروبي - CE Norme - CE Approval		Minimalna odległość od ściany - Минимальное расстояния до стены - المسافة الأدنى إلى الحائط - Distance minimale du mur - Minimum distance to wall		
	GS zatwierdzony produkt (test bezpieczeństwa) - Качество GS - منتجات مصدقة GS (معيار سلامة) - Produits avec GS qualification - GS approved products (tested safety)		Świeci w górę - Свет направленный вверх - ضوء نحو الأعلى - Luminosité vers le haut - Uplight	ZAREJESTROWANE MODELE / ПРАВА НА ДИЗАЙН ЗАРЕГИСТРИОВАНЫ / REGISTERED MODELS	
	Kwalifikacja efektywności energetycznej - Эффективное использование энергии - إستهلاك فعال للطاقة - Qualification d'efficacité d'énergie - Energy efficiency qualification		Zamontowane urządzenia - Настенные светильники - مصباح للجدران - Applique murale - Mounted fixture	C351: 000257464-0003 C352: 000257464-0004 C353: 000257464-0005 P5051: 000257464-0001 C354: 000257464-0006 P5050: 000257464-0002 C355: 000257464-0007 C356: 000257464-0008 P8050: 000995576-0003 P9900: 000995576-0004	
	Zawiera T5 HE lampy G5 - T5 HE G5 лампа прилагается - G5 HE T5 تتضمن لمبة T5 HE G5 - T5 HE G5 lamp include - T5 HE G5 lamp included		Świeci w dół - Свет направленный вниз - ضوء نحو الأسفل - Luminosité vers le bas - Downlight	C335: 000995576-0001 C336: 001035273-0001 C990: 000995576-0002 SX156: 000995576-0006	

PO		RU		AR							
Akcesoria	107	Skrzynki uciosowe	107	Принадлежности	107	Накладные панели	78	110	أدوات التسويق	105	مايكرولينكس
Obudowy biblioteczne	76	MycroLynx	105	Библиотечные системы	76	Молдинги	60-67	105-100	إضاءة	107	مسدس للغراء
Głowice (kolumny)	92-98	Nisze	83	Капитель колонны	92-98	Сандрики	74	101	إضاءة غير مباشرة	104	مصابيح للجدران
Ozdoby sufitowe	84	Panele	78	Потолочные украшения	84	Пилястры	91	72	إطارات للأبواب	112	معلومات السلامة
Płyty sufitowe	84	Profile dekoracyjne	60-67	Потолочная плитка	84	Polyurethane	38	98-91	أعمدة	112	مقاومة الإحتراق
Rozety	86-89	Frontony	74	Потолочные розетки	86-89	Purotouch®	38	98	أعمدة مجزأة	107	منشار
Kolumny	92-98	Pilastry	91	Колонны	92-98	Закругленные стены	71	91	أعمدة مسطحة للجدران	106	مواد لاصقة
Wsporniki	80	Poliuretan	38	Кронштейны	80	Информация по	74	74	أقواس	81	مواقد زينية
Gzymy	42-58	Purotouch®	38	Молдинги	42-58	безопасности	112	78	ألواح	97-95	نصف أعمدة
Elementy dekoracyjne	82	Zaokrąglone ściany	71	Декоративные	элементы	82	107	78	ألواح للأبواب	68	نعلات
DecoFix Extra	106	Informacje dotyczące		DecoFix Extra	106	Сборные колонны	98	84	ألواح للسقوف	89-86	ورديات للسقوف
DecoFix Hydro	106	bezpieczeństwa	112	DecoFix Hydro	106	Полки	80	103	أنبوب T5		
DecoFix Pro	106	Piła	107	DecoFix Pro	106	Плинтус	68	38	بوليوريثين		
Kopuły	05	Kolumny segmentowe	98	Купола	85	Кронштейн	92-98	38	بيوروتاتش®		
Obudowy drzwiowe	72	Półki	80	Дверное обрамление	72	T5 Верхний		108	تركيب		
Panele drzwiowe	78	Listwy przypodłogowe	68	Дверные панели	78	рассеиватель	103	71	جدران مقوسة		
Duropolymery®	40	Socle	92-98	Стандарт		Стуло	107	40	دوروبوليمر®		
Standardy		T5 Tube	103	огнестойкости	112	Дизайн стен	82	41	دوروفوم		
przeciwpożarowe	112	Variomatic	107	Светильники	104	Гарантия	112	106	ديكوفيكس إكسترا		
Kinkiety	104	Dekoracja Ćcian	82	Гибкие молдинги	71	Xinnix®	105	106	ديكوفيكس برو		
Profile gięte	71	Gwarancja	112	Клей	106			106	ديكوفيكس هايديرو		
Klej	106	Xinnix®	105	Пистолет для				80	رفوف		
Pistolet do kleju	107			выдавливания клея	107			98-91	رؤوس أعمدة		
Pół kolumny	95-97			Полуколонны	95-97			82	زينة للجدران		
Oświetlenie	100-105			Освещение	100-105			84	زينة للسقوف		
Oświetlenie pośrednie	101			Скрытое освещение	101			112	طلاء		
Montaż	108			Монтаж	108			107	عدة		
LED bars	102			Светодиодные панели	102			107	علب قص		
LED insert	105			Светодиодные вставки	105			85	قباب		
Kominki	81			Камины	81			102	قضبان LED		
Narzedzia marketingowe	110			Маркетинговые				98-92	قواعد أعمدة		
				инструменты	110			67-60	قوالب للجدران		
				Стуло	107			71	قوالب مرنة		
				MycroLynx	105			58-42	كرانيش		
				Ниши	83			112	كفالة		
				Краска	112			83	كوات		
								105	لمبات LED		

FR		EN	
Appliques	104	Accessories	107
Boîte à onglets	107	Byblos	76
Byblos	76	Capitals (columns)	92-98
Chapiteaux	91-98	Ceiling ornaments	84
Cheminées décoratives	81	Ceiling tiles	84
Cimaises	60-67	Ceiling roses	86-89
Colles d'installation	106	Columns	92-98
Colonnes	92-98	Corbels	80
Consignes d'incendie	112	Cornice mouldings	42-58
Colonne segmentée	98	Deco elements	82
Consoles	80	DecoFix Extra	106
Corbeaux > consoles	80	DecoFix Hydro	106
Corniches	42-58	DecoFix Pro	106
Coupoles	85	Domes	85
Dalles de plafond	84	Door frames 72 Door panels 78	
DecoFix Extra	106	Duropolymer®	40
DecoFix Hydro	106	Fire retardant standards	112
DecoFix Pro	106	Fixtures	104
Décoration murale	82	Flexible mouldings	71
Décoration de plafond	84	Glue	106
Demi-Colonnes	95-97	Glue pistol	107
Duropolymère®	40	Half Columns	95-97
Eclairage	100-105	Lighting	100-105
Eclairage indirecte	101	Indirect lighting	101
Eléments décoratifs	82	Installation	108
Encadrements > cimaises	60-67	LED bars	102
Encadrements de portes	72	LED insert	105
Etagères	80	Mantel pieces	81
Fûts de colonnes	92-98	Marketing tools	110
Garantie	112	Mitre box	107
Information de sécurité	112	MycroLynx	105
Installation	108	Niches	83
LED bars	102	Paint	112
LED insert	105	Panels	78
Marketing tools	110	Panel mouldings	60-67
Mitre box	107	Pediments	74
MycroLynx	105	Pilasters	91
		Polyurethane	38
		Purotouch®	38
		Rounded walls	71
		Safety regulations info	112
		Saw	107
		Segmented column	98
		Shelves	80
		Skirting	68
		Socle	92-98
		T5 Tube	103
		Variomatic	107
		Wall decoration	82
		Warranty	112
		Xinnix®	105

<b>B</b>	C321/C321F	43/44	CX100	52	CB531	56/57	FX200	107	K224	91	
B401	80	C322/C322F	43	CX101	53	CB531 bis	56	FX210	107	K240	91
B402	80	C331/C331F	44	CX106	53	<b>D</b>	FB13	107	K241	91	
B403	80	C332	45	CX107	53	D500	107	FB14	107	K250	91
B404	80	C332bis	43	CX108	52	D503	107	FB15	107	K251	91
B408	80	C333/C333F	45	CX109	52	D504	107	FB300	107	K253	91
B409	80	C334/C334F	45	CX110	52	D506	107	FB10	107	K254	91
B410	80	C335	47	CX111	51	D507	107			K255	91
B413	80	C335+P9901	47	CX112	52	D101	72	<b>G</b>		K1111	95/96
B414	80	C336	48	CX115	51	D1010	72	G40	82	K1121	95/96
B417	80	C337	47	CX123	52	D1014	72	G42	82	K1141	95/96
		C337bis	48	CX124	52	D102	72	G50	82	K3111	96/97
		C338	47	CX126	53	D200	72	G51	82	K3141	96/97
<b>C</b>	C339	45	CX127	53	D210	72				K1001	95/96
C200/C200F	44	C340	48	CX128	53	D210	72	<b>H</b>		K1101	95/96
C201/C201F	49	C351	58/101	CX129	53	D300	72/77	H100A	81	K3001	96/97
C211/C211F	43/49	C352	58/101	CX132	51/68	D310	72	H100B	81	K3101	96/97
C212/C212F	43/49	C353	42	CX133	51/68	D320	91	H100C	81	K3201	97
C213/C213F	43/44	C354	42	CX134	67	D62	72	H101A	81	K1131	95/96
C214/C214F	49	C355	42	CX136	53	DX119 - 2300	72	H101B	81	K1151	95
C215/C215F	43	C356	42	CX141	54	DX121 - 2300	72			K2131	96/97
C216/C216F	49	C357	58/101	CX142	54	DX157 - 2300	55/67/68	<b>I</b>		K3151	97
C217/C217F	45	C358	58/101	CX143	54	DX159 - 2300	55/68	IL000-001	59/100	K4131	98
C217 bis	45	C360	42	CX148	52	DX162 - 2300	55/67/68	IL000-002	59/100	K4001	98
C218/C218F	50	C361	58/101	CX149	54	DX163 - 2300	55/67/69	IL002-001	103	K4121	98
C219	50	C362	58/101	CX150	54	KX001	73	IL002-002	103	K1112	92/93
C220/C220F	44	C363	58/101	CX151	54	KX003	73	IL002-003	103	K1122	92/93
C230/C230F	42	C364	58/101	CX152	54	D120	74	IL003-011	105	K1142	92/93
C240/C240F	44	C364A	58/101	CX153	54	D140	74	IL003-012	105	K3112	93/94
C250/C250F	42	C400	44	CX154	51	D150	74	IL004-001	102	K3142	93/94
C260/C260F	42	C402/C402F	49	CX160	51	D161	74	IL004-002	102	K1002	92/93
C300	47	C422	50	CX161	51	D170	74	IL004-003	102	K1102	92/93
C301/C301F	50	C602/C602F	43	CB500	56	D400	74	IL004-004	102	K3002	93/94
C302/C302F	49	C900	45/59/100	CB501	56	D401	74	IL004-005	102	K3102	94
C303/C303F	50	C901/C901F	45/59/100	CB502	57	D402	75	IL004-006	102	K3202	94
C304/C304F	49	C902/C902F	45/59/100	CB503	57	<b>F</b>		IL004-007	102	K1132	92/93
C305	43	C990	46	CB510	56	F10	85			K1152	92
C305+C212	43	C990+P9900	46	CB511	57	F11	85	<b>K</b>		K2132	93/94
C305+C213	43	C990+2x P9900	46	CB512	57	F12	85	K200	75/91	K3152	94
C305+C211	43	C990+P9900 bis	46	CB520	56	F30	78/84	K201	91	K4002	98
C305+C321	43	C990+P9901	47	CB521	57	F31	78/84	K201LR	75/91	K4122	98
C307	50	C990 bis	46	CB522	57	FDP500	107	K202	91	K4132	98
C307A	50	C990 bis+2x P9900	46	CB523	56	FDP600	107	K220	91		
C307+C307A	50	C990 bis+P9900 bis	46	CB530	56	FDP700	107	K221	91		
C308/C308F	50	C990 bis+P9901	47	CB530 bis	56			K223	91		

**L**

L501	104
L504	104
L505	104
L506	104
L509	104
L512	104
L600-001	105
L601-001	105

**M**

M9010A	77
M9010B	77
M9010C	77
M9010LR	77

**N**

N403	83
N404	83
N410	83
N503	83
N504	83
N510	83
N520	83

**P**

P101A	64
P20	64
P20+P101A	64
P201A	64
P21	64
P21+P201A	64
P1020/P1020F	63/64
P2020/P2020F	63/64
P3020/P3020F	63
P4020/P4020F	60
P4020A+P4020	62
P5020/P5020F	61
P5021/P5021F	60
P5050	62
P5051	61
P6020/P6020F	63
P7010/P7010F	64

P7020/P7020F	64
P7030/P7030F	63
P7040/P7040F	63
P7050/P7050F	63
P7060/P7060F	63
P7070/P7070F	61
P7080	64
P801C+P8020	62
P8020/P8020F	60
P8030/P8030F	60
P8030C+P8030	62
P8040/P8040F	62
P8050/P8050F	62
P8060/P8060F	60
P9010/P9010F	61
P9020/P9020F	61
P9040/P9040F	60
P9050/P9050F	60
P9900/P9900F	46/61
P9901/P9901F	47/60
P4020A	62
P5020A	61
P5020B	61
P801C	62
P8030C	62
P8030D	62
PB513	57
PB513A	57
PX102	67
PX103	65
PX103A	67
PX103A+PX103	67
PX113	66
PX114	66
PX116	65
PX117	66
PX120	66
PX120A	67
PX120A+PX120	67
PX131	66
PX144	66
PX145	66
PX146	66
PX164	51/67

**R**

R07	86
R08	86
R09	86
R10	87
R11	87
R12	87
R13	87
R14	87
R16	88
R17	88
R18	88
R22	88
R23	89
R24	89
R27	89
R28	89
R31	87
R35	86
R38	89
R40	86
R46	88
R50	87
R52	89
R61	87
R64	89
R66	86
R73	89
R74	88
R76	86
R77	88

**S**

SX104	69
SX105/SX105F	69
SX118/SX118F	69
SX155/SX155F	69
SX156	69
SX122	68
SX125	68
SX137	68
SX138	69



42



60



68



71



72



74



76



78



80



82



83



84



86



91



92



100





Chcielibyśmy podziękować wszystkim, którzy pomogli w tworzeniu tego katalogu. Мы благодарны всем, кто помогал в создании данного каталога.

نود أن نشكر كل الذين ساعدوا على إنجاز هذا الكتيب. Nous remercions tout le monde qui a collaboré à la réalisation de ce catalogue.

We would like to thank everybody who helped with the creation of this brochure.

Projects: 'Coca-Cola Loge' by Pinkeye (BE) - [www.pinkeye.be](http://www.pinkeye.be)  
Hotel Majestic (ES) - [www.hotelmajestic.es](http://www.hotelmajestic.es)  
Restaurante Boca Grande (ES)  
[www.metiendovivendum.com](http://www.metiendovivendum.com)

Eichholtz A'dam (NL) - [www.eichholtz.com](http://www.eichholtz.com)  
Hotel the Black Antwerp (BE) - [www.hoteltheblack.be](http://www.hoteltheblack.be)  
Restaurante La Rambla by Ana Generó (ES) - [www.larambla.biz](http://www.larambla.biz)  
[www.houseofporters.com](http://www.houseofporters.com)

Balo 'Living in Style' (BE)- [www.balolivinginstyle.be](http://www.balolivinginstyle.be)  
Private residence, Ponsele (BE) - [www.patrickponsele.be](http://www.patrickponsele.be)  
Hotel Alma (ES) - [www.almabarcelona.com](http://www.almabarcelona.com)

This catalogue and the designs embodied within are protected by copyright law and international treaties. Unauthorized reproduction of the catalogue or any portion of it or reproduction of any of the designs embodied therein may result in severe civil and criminal penalties and will be prosecuted to the maximum.

★ **ORAC HEADQUARTERS**

**NV ORAC SA**

BIEKORFSTRAAT 32,  
8400 OSTEND, BELGIUM  
T +32 (0)59 80 32 52  
F +32 (0)59 80 28 10  
INFO@ORACDECOR.COM

★ **ORAC FRANCE**

T 0800-900 358  
F +32 (0)59 80 28 10  
FRANCE@ORACDECOR.COM

★ **ORAC (UK) Ltd.**

ELMBRIDGE ROAD UNIT 5  
HEWITTS ESTATE  
CRANLEIGH, SURREY  
GU6 8LW  
UNITED KINGDOM  
T +44 (0)1483 271 211  
F +44 (0)1483 278 317  
UK@ORACDECOR.COM

★ **ORAC SLOVAKIA S.R.O.**

KPT. NALEPKU 6  
SK-08271 LIPANY  
T +421 (0)514-891 581  
F +421 (0)514-573 595  
SLOVAKIA@ORACDECOR.COM

★ **ORAC NEDERLAND**

T 0800-022 2125  
F 0800-022 2138  
NEDERLAND@ORACDECOR.COM

★ **ORAC DEUTSCHLAND**

T 0800-181 3694  
F +32 (0)59 34 05 24  
DEUTSCHLAND@ORACDECOR.COM

★ **ORAC SPAIN**

T 0900 99 32 89  
F +32 (0)59 80 28 10  
SPAIN@ORACDECOR.COM